

ALBANY SHED CO
FLOOR PLAN: 909 RUTLAND 2.7 x 2.7m approx.

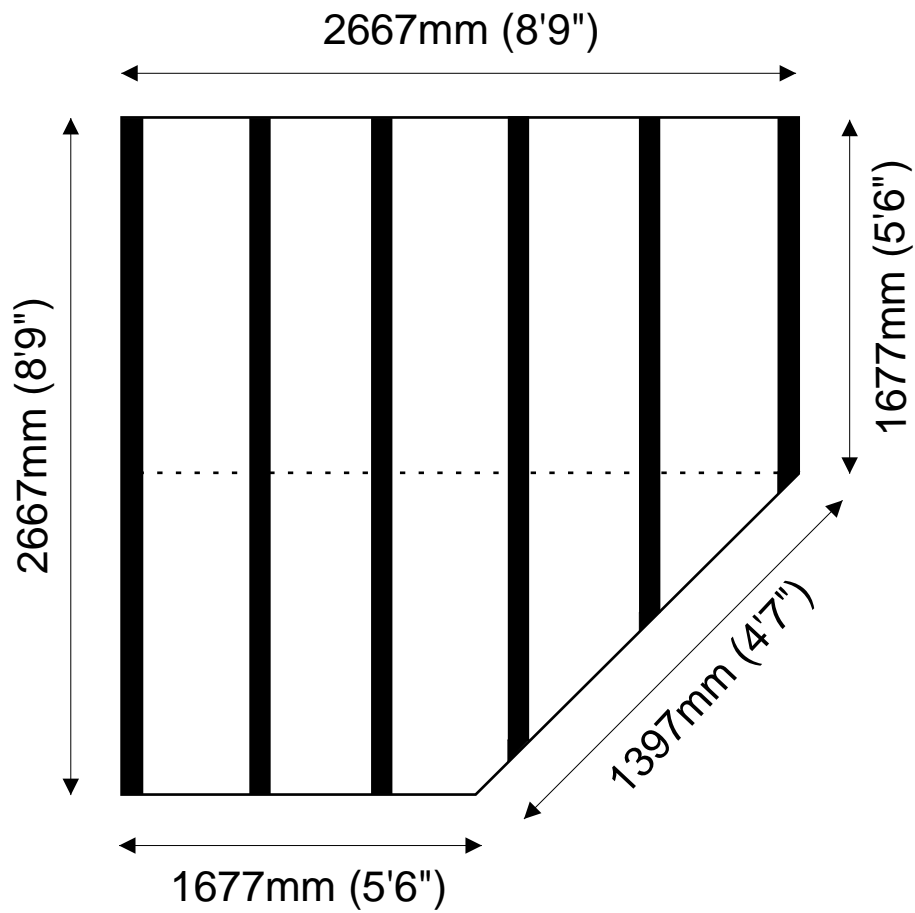

We reserve the right to alter design without prior notice