

Inspiring Outdoor Spaces

PORCELAIN & NATURAL STONE

TALASEY

LANDSCAPING SOLUTIONS



20 YEARS OF
TALASEY



OUR MISSION

Through our people,
we strive to enrich the lives of others
by providing landscaping products
and solutions via a network of
dedicated service providers.



Talasey's ability to assist their customers and provide reliable service is a testament to their dedication and professionalism.

Thank you Talasey keep up the support you give to Chameleon Landscaping Ltd and for the support you give to the landscape industry!"

- Patrick Dwyer, Chameleon Landscaping

CONTENTS

Totally Talasey	6
Trust in Talasey	8
Purchasing Our Products	10
Supporting Our Industry	12
Talasey Training Academy	14
Porcelain Paving	16
Porcelain Paving	18
Porcelain Cobbles	44
Porcelain Edging	45
Porcelain Cladding	46
Considerations	48
Natural Stone Paving	52
Premiastone	54
Cragstone	64
Classicstone	70
Fossestone	94
Cobblestone	106
Stone Accessories	112
Considerations	120
Bespoke Service	122
Paving Installation & Maintenance	126
Priming Slurry	128
Jointing	130
Adjustable Risers	134
Edgings	136
Accessories	137
Drainage	138
Cleaners	140
Sealers	142
Terms & Conditions	144

TOTALLY TALASEY

At Talasey Landscaping Solutions, we've been inspiring outdoor spaces for 20 years. In this time, we have built a strong foundation of landscaping brands, each showcasing a wide range of products and solutions which complement one another, to enable you to create your perfect landscape.

And it doesn't end there! As a trusted brand, Talasey brings you more than just products and solutions, but also a network of supply chain partners.

Our team offer dedicated knowledgeable support, which further extends through our Designer and Installer Network.

At Talasey, we will support you through every step of your project journey. Whether you are looking for inspiration and ideas, or ready to find your installer and get started, we're here to help.

We invite you to sit back, relax, and discover our range of product brands to understand how they can work together to make your landscaping dreams a reality.



Look out for QR codes for more information online



VITRIPIAZZA®
Vitrified Porcelain Paving

PORCELAIN PAVING & ACCESSORIES



PIRANHA
COMPOSITE SOLUTIONS

COMPOSITE DECKING, FENCING & CLADDING



NATURAL PAVING®
be inspired...

NATURAL STONE PAVING & ACCESSORIES

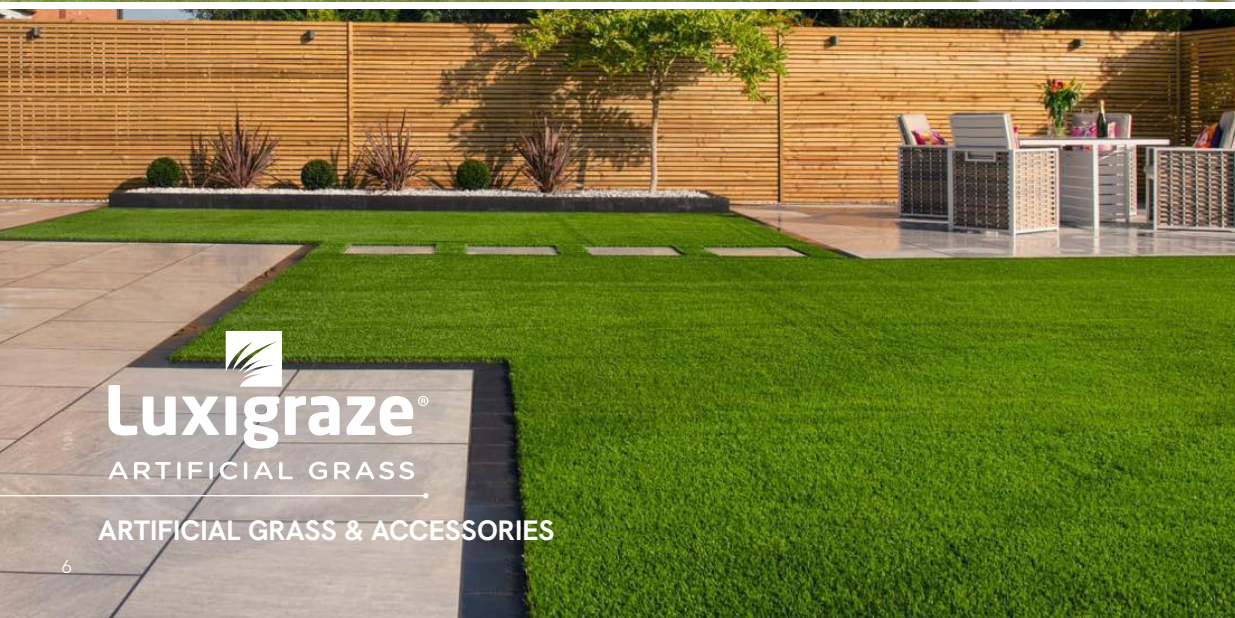

Luxigraze®
ARTIFICIAL GRASS

ARTIFICIAL GRASS & ACCESSORIES



Pavetuf®
Landscape Solutions

INSTALLATION & MAINTENANCE ACCESSORIES

TRUST IN TALASEY

We work tirelessly to offer premium landscaping solutions and we are constantly investing in our people and our technology to ensure that we deliver first class customer experiences.

Here are just some of the reasons why our customers can rely on us as a true 'one-stop shop' to provide their hard landscaping solutions:



Extensive Range of Products Readily Available

We have a large stock holding across 3 UK distribution centres.



Ethically & Responsibly Sourced Products

We are proud members of the Ethical Stone Register and we are fully FSC® certified for our range of Piranha products.



Sample Service

We offer a free sample service directly to branch and home.



Designer & Installer Network

A dedicated network which provides support to landscapers and designers, who are trustworthy professionals for homeowners.



Multiple Training Options

We offer multiple training options suitable for merchants, landscapers and DIYers.



Technical Support

Our knowledgeable and experienced team are on hand to answer any technical and installation enquiries you may have.



Direct to Site & Home Delivery

Our direct to site delivery option means we can ship orders directly to the project site.



Continued Support

In the unlikely event that you aren't 100% satisfied with your purchase, our Customer Care team are here to help. Simply give them a call on **0330 333 8030** or send an email to **customer@talasey.co.uk** along with your order information, and a member of our helpful team will provide you with further assistance.



We support our network of UK builders merchants and stockists by only selling our core products through them. Simply contact our Customer Engagement team for more details of your local suppliers.



Corporate Responsibility

Talasey are passionate about responsible trading and wholeheartedly invest in our ethical supply chains and the people that work in them, and we are proud members of the Ethical Stone Register.

All of Talasey's composite decking, fencing and cladding in our Piranha range is 100% FSC certified.

We are committed to the sustainability of our products and packaging and are regularly reviewing and updating them to be more environmentally friendly and recyclable where possible.

You can rest assured that our products have been fully tested, are compliant to the latest regulations and that our ethical supply chain is fully audited and market leading.



Purchasing our products for your garden

In 5 Simple Steps

1

Find your inspiration

Our brochure is bursting with inspiration and ideas for your next landscaping project, so why not grab a drink and take some time to browse our collection.



[pinterest.co.uk/
talaseylandscapingsolutions](https://www.pinterest.co.uk/talaseylandscapingsolutions)

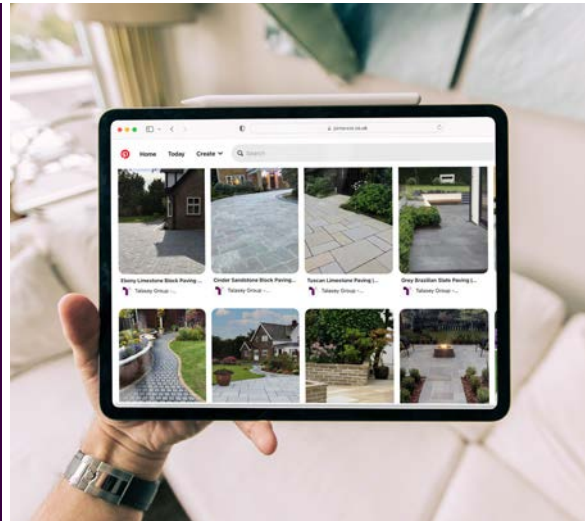

2

View before you buy

We recommend you see the product in person where possible before ordering, make use of our handy online sample service to order your samples directly to your door. Alternatively, you can head to your nearest display area, contact us to find yours.



3

Find your Landscaping Professional

Our Designer & Installer Network is a select group of members we have partnered with to deliver high-quality design and installation of our ranges. Contact us to find your nearest members. If you're considering undertaking an installation yourself, head to the Knowledge Hub on our brand sites for a range of in-depth, step-by-step installation guides.

4

Place your order

Contact us to place your order via our local stockist, choosing your preferred delivery option:

DIRECT TO SITE

Contact our Estimating team on **01302 965743**, who can handle all of your enquiries and process your order for delivery directly to your home.

DIRECT TO BRANCH

We can deliver your order into your nominated merchant, where they will happily arrange delivery or collection of your order.

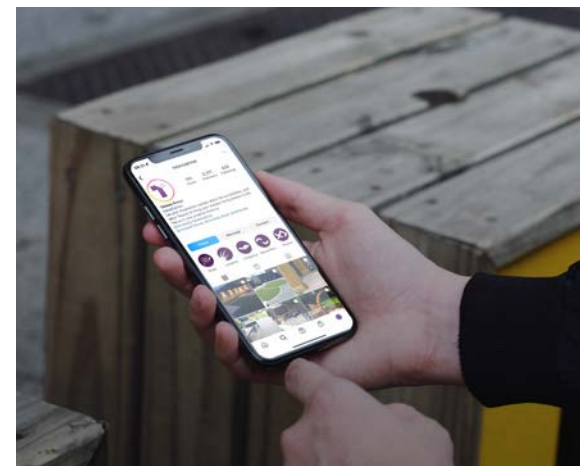

5

Share your project with us and enjoy

Enjoy your new landscape for years to come. Don't forget to tag us in your projects on social.

[@talaseylandscapingsolutions](https://www.instagram.com/talaseylandscapingsolutions)
[#InspiredByTalasey](https://www.instagram.com/InspiredByTalasey)



SUPPORTING OUR INDUSTRY



Perennial

Perennial is the UK's only charity dedicated to helping everyone who works with plants, trees, flowers or grass, and their families. They offer free advice, information and support to all those in horticulture whether working or retired, at any stage of life.

There are lots of reasons why people turn to Perennial such as bereavement, the impact of an accident, health issues or a family breakdown. Their friendly and experienced team are on hand when needed and many also access the wealth of free advice and information available online and via their free health & wellbeing and money management tools.

As a Diamond Plus partner, Talasey are proud to support the Perennial charity and help spread awareness of their amazing cause to our industry colleagues.



Perennial was there for me in my hour of need and may well have saved my life. It sounds dramatic, but their calm guidance at a time when my life was in turmoil massively helped me.

Peter, Landscape Gardener



Peter, Landscape Gardener

Band of Builders

Band of Builders is a national construction charity that provides support to members of the UK construction industry facing life changing circumstances.

As National Landscaping Partner, we pledge to support the charity by donating our products to their projects as well as raising awareness for their cause through support and fundraising.



For each tub of Pavetuf Jointing Compound sold, 5p goes to Band of Builders charity.



BoB Big Brew

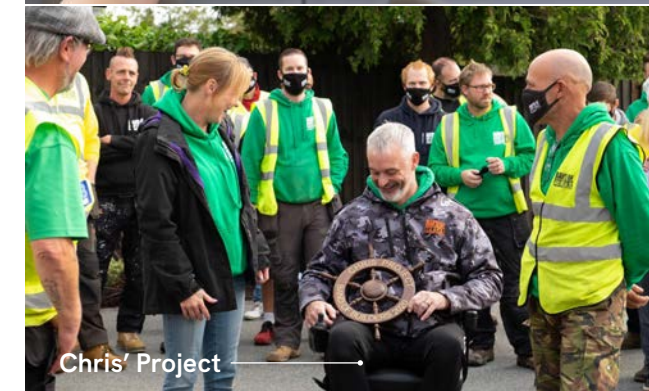

Chris' Project

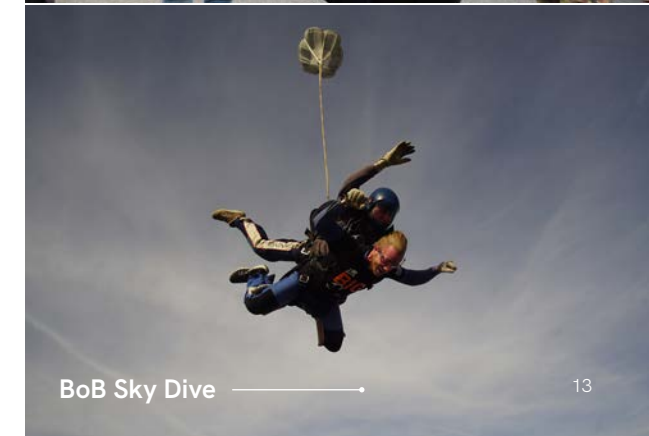

BoB Sky Dive

TALASEY

TRAINING ACADEMY



Product Installation Courses

Our range of product installation courses include:

- ▶ **Basic Site Setting Out and Preparation**
- ▶ **Installation of Porcelain Paving Materials**
- ▶ **Installation of Stone Paving Materials**
- ▶ **Installation of Composite Decking & Cladding**
- ▶ **Installation of Artificial Grass**



Scan the QR code to view our full course prospectus.



Talasey On Tour

Coming to a town near you!

Our mobile showroom travels all over the country, visiting a number of our merchant suppliers, whilst also attending many landscaping events and exhibitions, to showcase our range of products, solutions and services. With knowledgeable and hands-on staff, Talasey on Tour is an ideal way to experience and understand product features and benefits, whilst seeing and feeling our products first hand.

Product Awareness Course

For those who sell Talasey products, we have our bite-sized product awareness courses, which equip merchants with the knowledge they need to sell our products to their trade customers.

All of our courses are designed to cover domestic applications, and are held at our purpose built training facility in Lincolnshire.



PORCELAIN PAVING

HARD WEARING
ITALIAN INSPIRED LUXURY

VITRIPIAZZA[®]
Vitrified Porcelain Paving
BY TALASEY LTD

Talasey's porcelain range, **Vitripiazza**, offers quality porcelain paving solutions for external patios and driveways, internal tiles and wall cladding. With something to suit all styles and budgets, our range of Italian inspired porcelain paving provides homeowners with a contemporary, low maintenance, landscaping solution.

STRONG & HARDWEARING



- ▶ Resistant to salt and acid.
- ▶ Higher resistance to algae and mould.
- ▶ Low water absorption.
- ▶ Frost resistant.

SLIP RESISTANCE



All external Vitripiazza products are classified as low slip potential.

NATURAL BEAUTY



Each porcelain flagstone offers a varied colour blend, with numerous patterns to reflect natural landscaping materials.

VITRIFIED PORCELAIN



All of our ranges are vitrified porcelain. Quality is assured from Talasey with specifications to suit all styles and budgets.

HIGH STAIN RESISTANCE



The low porosity of Vitripiazza means that spills and general soiling are less likely to soak into the flag, making them easier to clean and highly resistant to staining, negating the need for sealers.

DID YOU KNOW?

Much like wallpaper, porcelain is produced in batches, which must be considered during ordering and installation. Learn more about porcelain batch matching here.

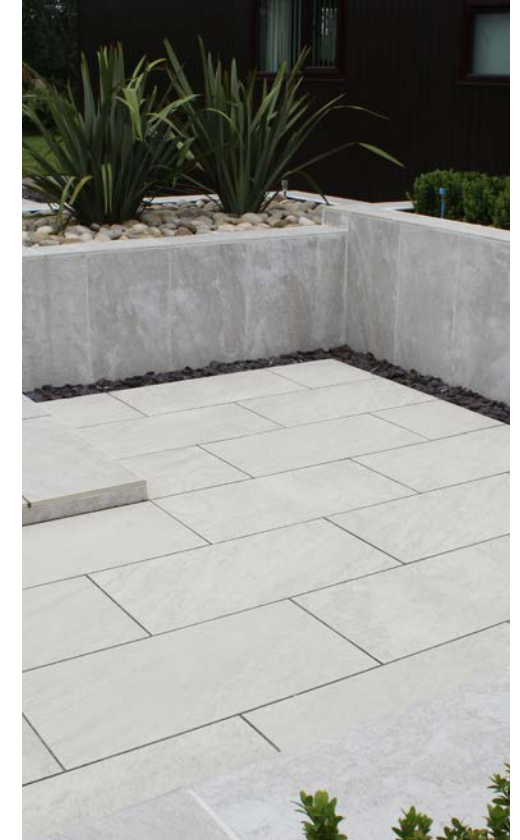

Di Pietra, Tempesta

What our customers say...

Our Vitripiazza porcelain has helped us transform our garden into a space we are proud to show off to all of our friends and family, and everyone comments on how great the new patio looks!

- Mitch & Steph, Homeowners

Colosso

£££

Colosso is a chic and lavish large format porcelain flagstone. Presenting a modern, concrete finish, this porcelain paver gives a real 'wow' factor.

Pack Sizing

1200x1200mm
 Thickness: 20mm
 Coverage: 28.80m²
 Weight: 1354kg
 Contains: 20 pieces

1200x600mm
 Thickness: 20mm
 Coverage: 25.20m²
 Weight: 1167kg
 Contains: 35 pieces

Please note these products are made to order.

Matching internal tiles also available to order.



Charis

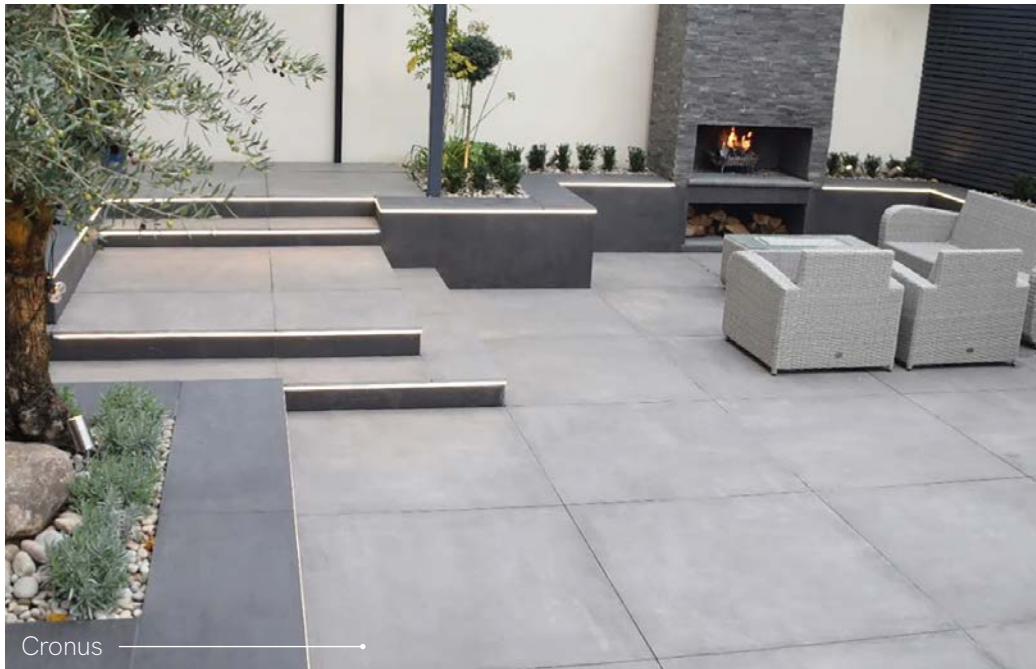

Cronus



Athos



Thea



Athos



Charis



Cronus



Ravana

Di Pietra

Inspired by nature, Di Pietra is a contemporary range of porcelain paving which gives a slightly textured, random, natural stone finish.

Pack Sizing

1200x600mm
Thickness 20mm
Coverage: 25.20m²
Weight: 1167kg
Contains: 35 pieces

Please note these products are made to order.

£££

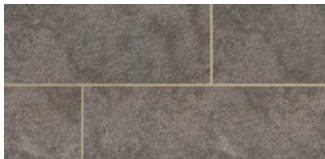
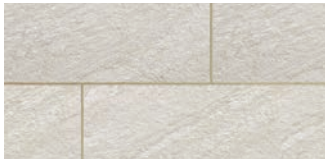
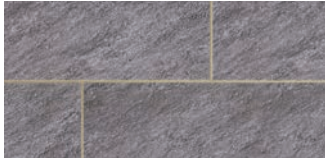



Lune →

Sofia

Sofia is a stunning range of large porcelain pavers presenting a marble effect finish, available in a choice of 3 colours.

Pack Sizing

- 800x800mm
- Thickness: 20mm
- Coverage: 19.20m²
- Weight: 840kg
- Contains: 30 pieces



Lune →



Montagne →



Stelle →

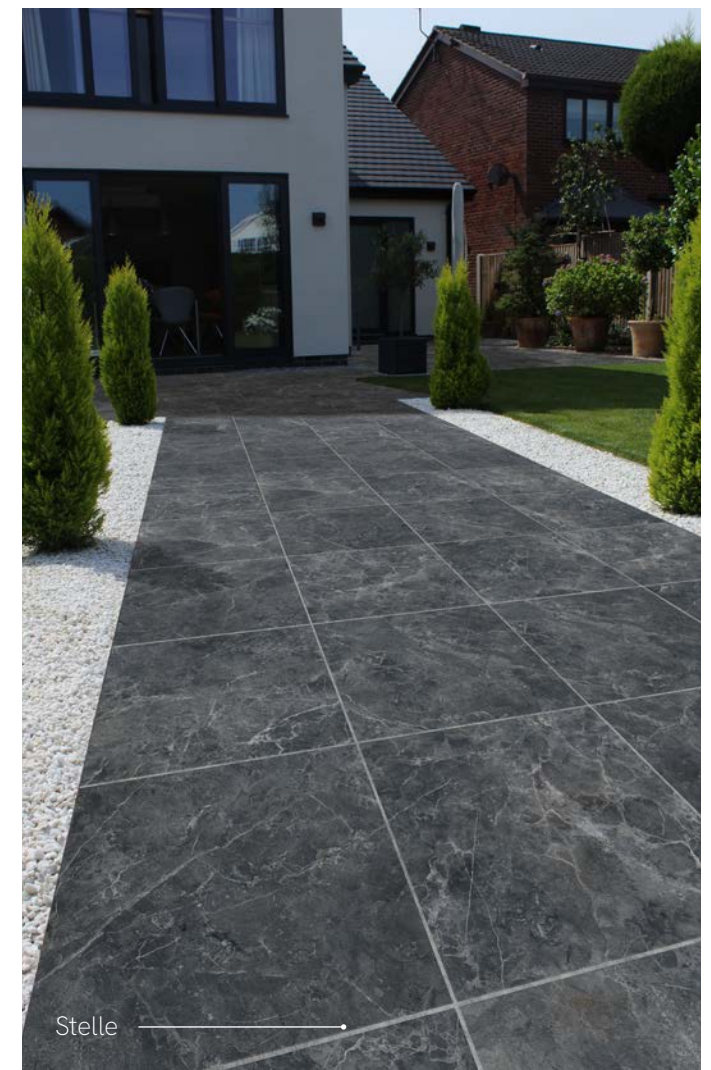

Stelle →

Anno

The Anno range presents 4 beautiful colours, each with a natural stone appearance.

Pack Sizing

600x600mm
Thickness: 18mm
Coverage: 23.04m²
Weight: 938kg
Contains: 64 pieces

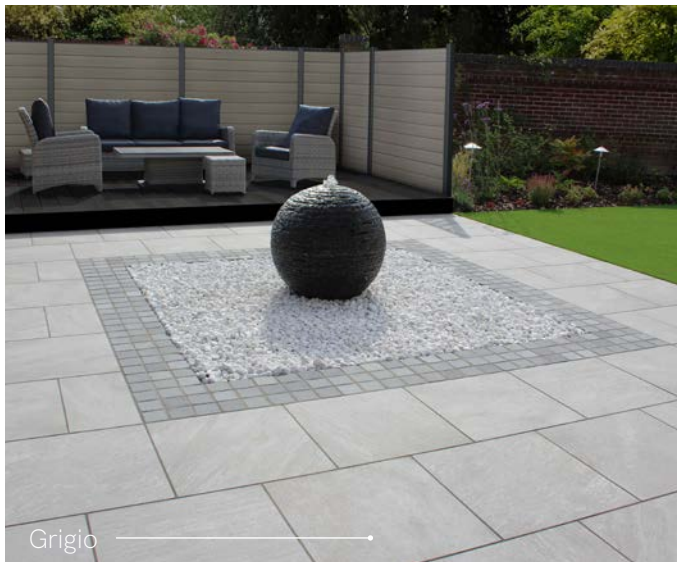

Grigio



Pantera



Avorio



Grafite

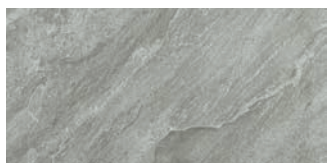

Grigio

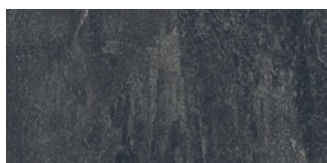

Pantera



Avorio (Product shown wet)



Grigio

££

Anno Lite

Anno Lite is a lighty textured paver which presents a 3D effect print, giving the appearance of a riven natural stone.

Pack Sizing

800x800mm
Thickness: 16mm
Coverage: 25.6m²
Weight: 870kg
Contains: 40 pieces



Pearl



Grey



Buff



Buff



Grey

£

Bellezza Lite

Bellezza Lite presents a lightly textured, natural stone porcelain paver, available in a choice of 3 colours. With a reduced carbon footprint, this porcelain paver also comes with less packaging, making it more eco-friendly.

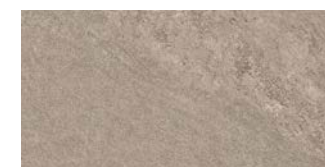

Fino



Lago

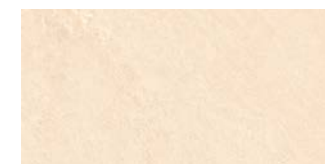

Riva

Pack Sizing

600x600mm
Thickness: 16mm
Coverage: 28.08m²
Weight: 1036kg
Contains: 78 pieces

800x800mm
Thickness: 16mm
Coverage: 25.6m²
Weight: 870kg
Contains: 40 pieces

900x600mm
Thickness: 16mm
Coverage: 28.08m²
Weight: 1036kg
Contains: 52 pieces



Riva

Lago

Bellstone

Bellstone offers a riven effect natural stone feel, available in a choice of three bold colours.

Pack Sizing

600x600mm
Thickness: 20mm
Coverage: 23.04m²
Weight: 1072kg
Contains: 64 pieces

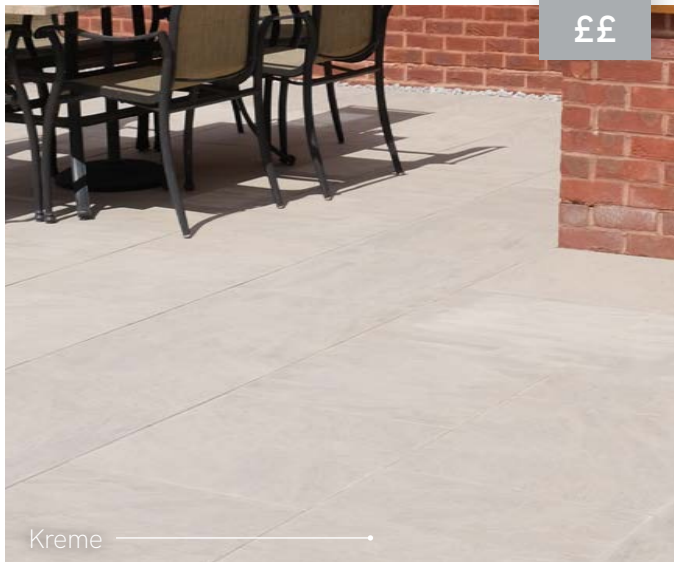

££

Traverta

Traverta presents a large format porcelain with a travertine style finish.

Pack Sizing

- 1200x600mm
- Thickness: 20mm
- Coverage: 23.04m²
- Weight: 1092kg
- Contains: 32 pieces

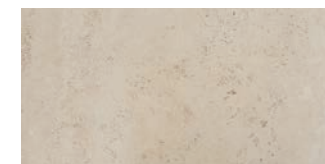

Classic Cream

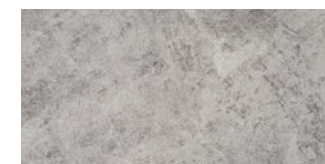

Tundra Grey



Tundra Grey



Tundra Grey (Product shown wet)



Classic Cream

Plank

A wood effect, sleek plank format porcelain, available in a choice of three striking colours.

Pack Sizing

1200x330mm
Thickness: 20mm
Coverage: 23.76m²
Weight: 1079kg
Contains: 60 pieces

££



Light Oak



Grey Oak



Burnt Oak



£

Cava Stone

Cava Stone offers a porcelain alternative to the popular grey and buff natural sandstone flagstones.

Pack Sizing

900x600mm
Thickness: 20mm
Coverage: 21.60m²
Weight: 1020kg
Contains: 40 pieces



Kandla Grey



York Stone



York Stone



Kandla Grey



Also available in a 200x200mm cobble option, see page 44 for details

Pewter (Product shown wet)

Cava Granito

£

Cava Granito presents a porcelain flagstone option that replicates stunning silver and grey natural stone granites.



Pewter



Silver Grey

Pack Sizing

- 900x600mm
- Thickness: 20mm
- Coverage: 21.60m²
- Weight: 1020kg
- Contains: 40 pieces

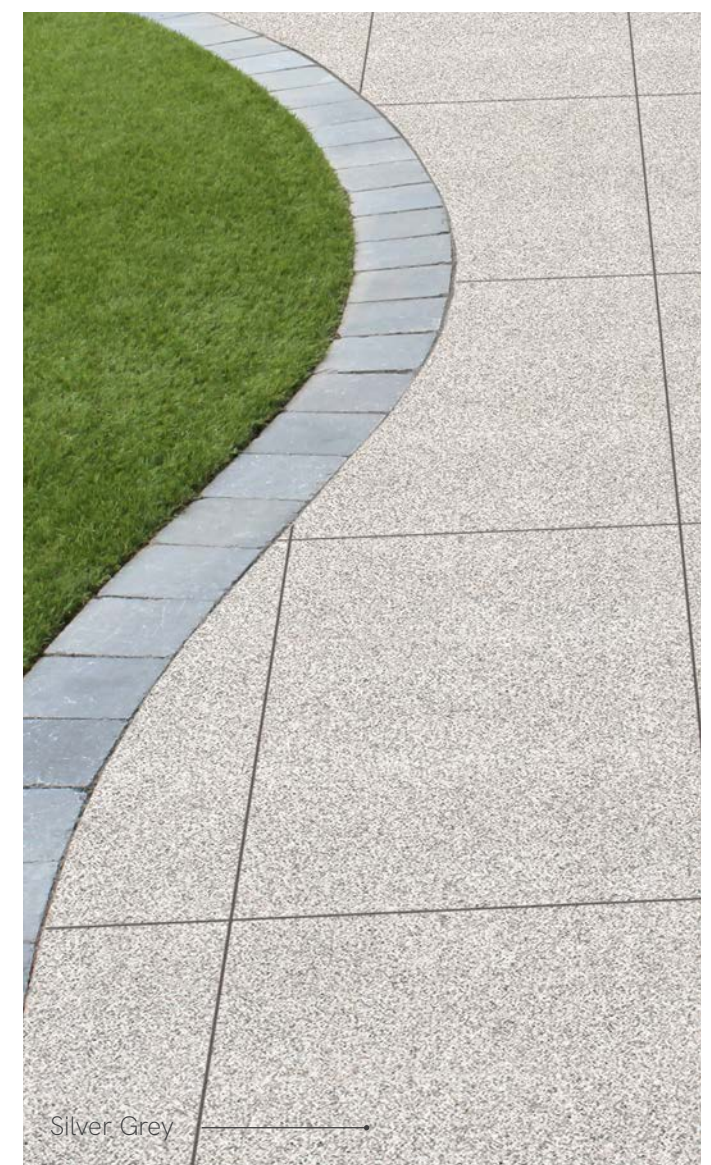

Silver Grey

Cava Quartz

Cava Quartz is a beautiful collection of porcelain flagstones, each with a natural stone quartzite finish.

Pack Sizing

600x600mm
 Thickness: 20mm
 Coverage: 23.04m²
 Weight: 1008kg
 Contains: 64 pieces

900x600mm
 Thickness: 20mm
 Coverage: 21.60m²
 Weight: 940kg
 Contains: 40 pieces

1200x600mm
 Thickness: 20mm
 Coverage: 21.6m²
 Weight: 945kg
 Contains: 30 Pieces

Also available in a 900x200 edging option, see page 45 for details

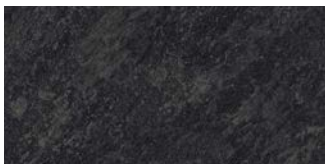

Lustre

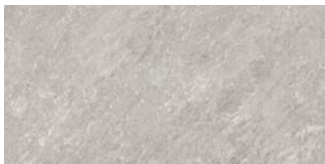

Lucenta

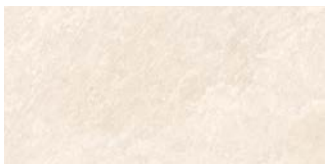

Lucio

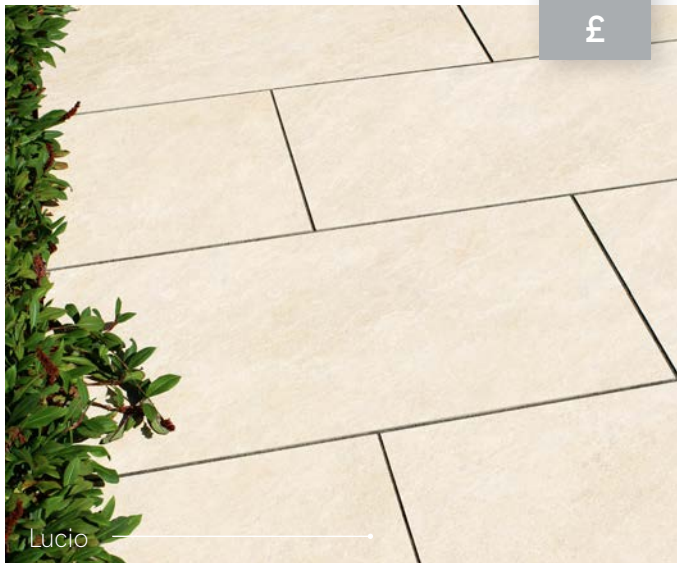

Lucio

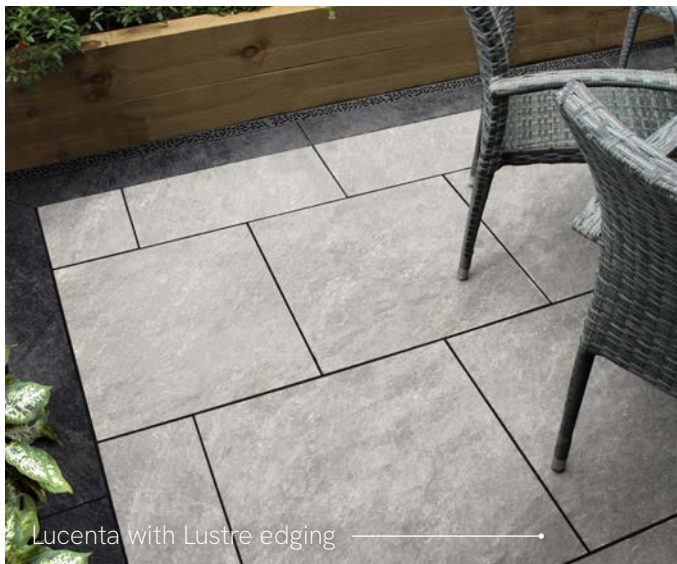

Lucenta with Lustre edging



Lucio

£



Lustre

Dusk

A contemporary, smooth and polished concrete style paving, ideal for creating a modern outdoor living space.

Pack Sizing

900x600mm
Thickness: 20mm
Coverage: 21.60m²
Weight: 1020kg
Contains: 40 pieces

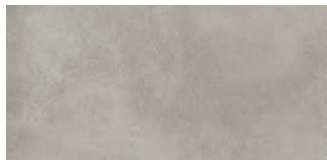
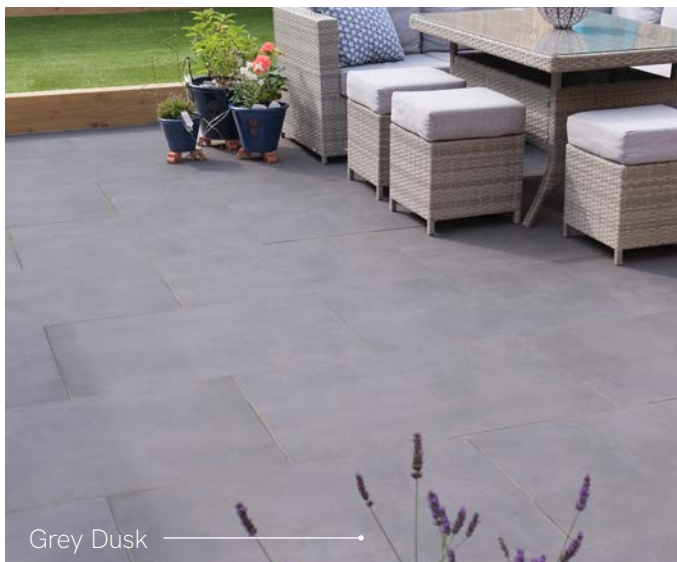
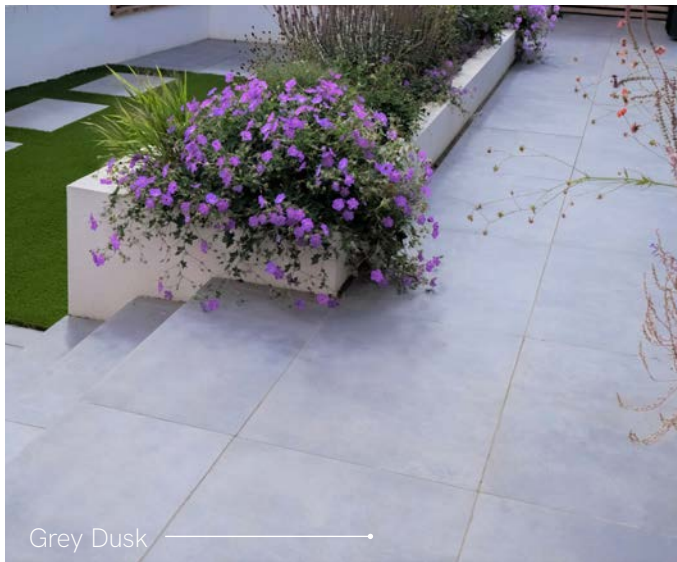
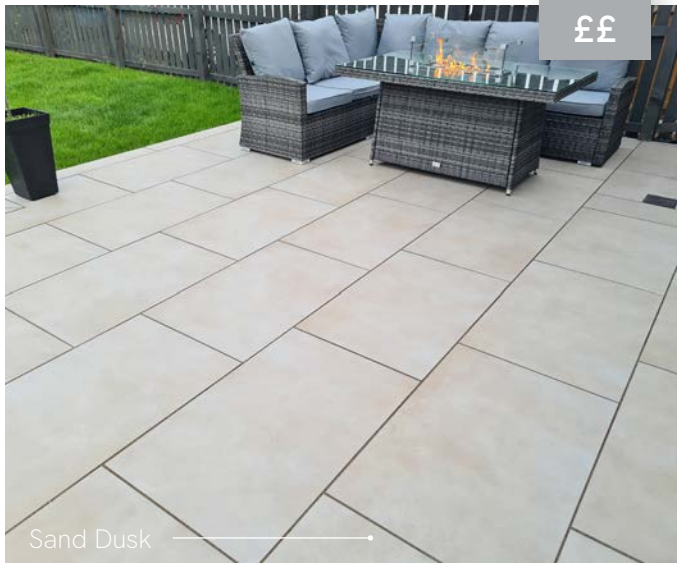

Sand Dusk

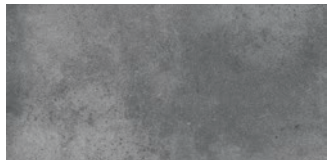

Grey Dusk



Cobbles

Our range of porcelain cobbles offer a granite effect finish and are available in a choice of 2 colours. They provide a modern cobble solution and are ideal for creating edgings and focal points in your landscaped area.

Pack Sizing

200x200mm
Thickness: 20mm
Coverage: 0.36m²
Weight: 15.5kg
Contains: 9 pieces



Pewter



Silver Grey



Pewter Cobble

££



Lucenta Edging

Edgings

Our porcelain edgings are available in a choice of three colours, with a natural quartzite finish. Ideal for creating borders and detail to your paved area.

Pack Sizing

900x200mm
Thickness: 20mm
Coverage: 22.68m²
Weight: 985kg
Contains: 126 pieces

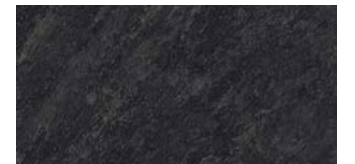

Lustre



Lucenta

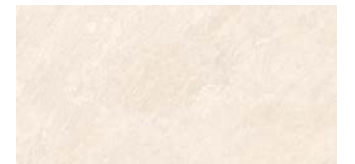

Lucio



Lustre Edging

££



White

Cladding

The Rok Cladding range is a densely textured natural stone effect porcelain cladding, that gives a modern and random block effect.

Pack Sizing

385x75mm
Thickness: 8-12mm
Coverage: 0.75m²
Weight: 14kg
Contains: 26 pieces

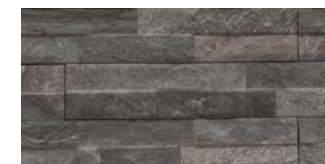

Black



Green

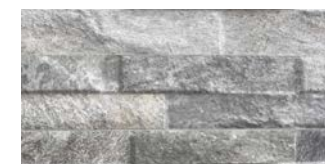

Grey



White

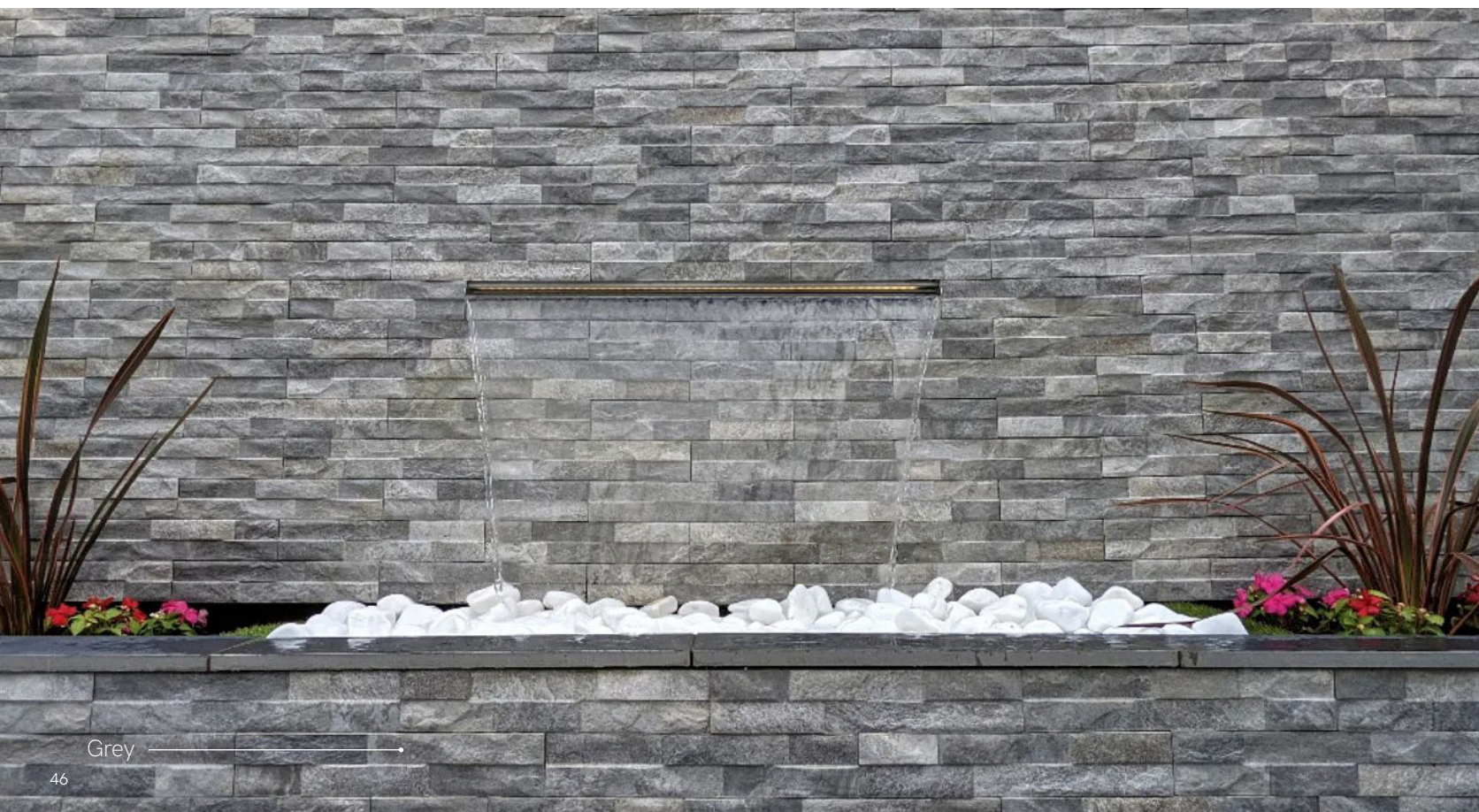

Grey

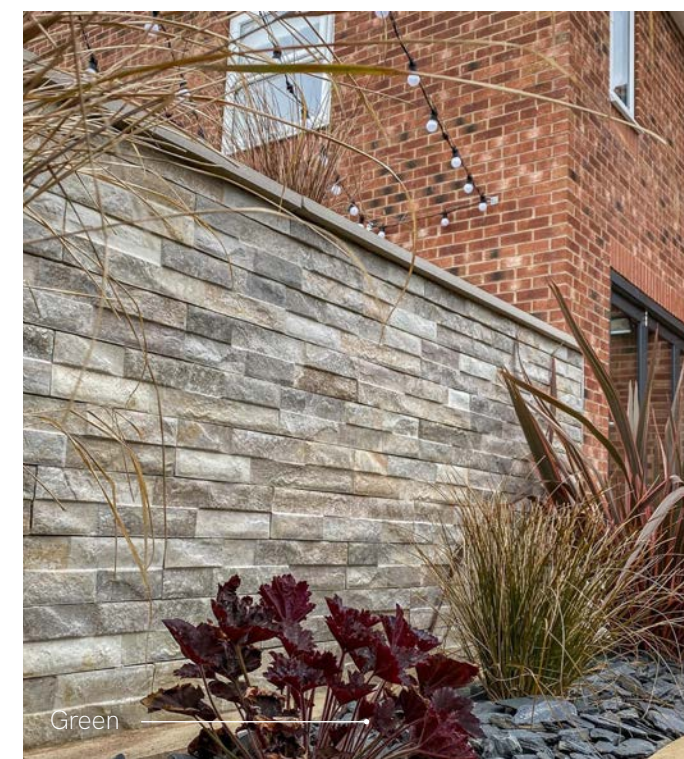

Green

Considerations

BATCHING

Porcelain products are a little like wallpaper, in that, the production batches are important.

As with wallpaper, the same colour and print are used in every production run however there can be a slight shade variation between each batch. Every Vitripiazza range will have its own date of manufacture and/or shade number reference. This forms the batch number or batch date, required for matching products for one project.

We strongly recommend that sufficient product for each project is purchased together and from the same production batch, as there may be slight colour variations between different batches.

It's **IMPORTANT** before unpacking that you check the shade references are compatible if you have received more than one pallet.

We recommend you keep a note of your batch number for any potential future orders, in case a batch match is possible.

PRODUCT MEASUREMENTS

All product sizes, weights and coverages stated throughout this brochure are nominal and subject to manufacturing tolerances.

COLOUR BANDING

Even when shades are batch matched, it is best practice that the installer mixes the paving tiles from multiple packs when installing any Vitripiazza product, to avoid any potential colour banding.

COST

When it comes to considering the cost of the product range you choose we have added simple symbols to assist you in your choice. Consider that 80% of the cost of a project is made up of the base elements and installation underneath that you do not see. The paving actually only forms 20% of the overall cost, so choosing a premium quality paving will not significantly add to the overall project costs.

SIZE COMPARISON

The Vitripiazza range presents various size formats, from show stopping 1200x1200mm through to the popular 600x600mm.

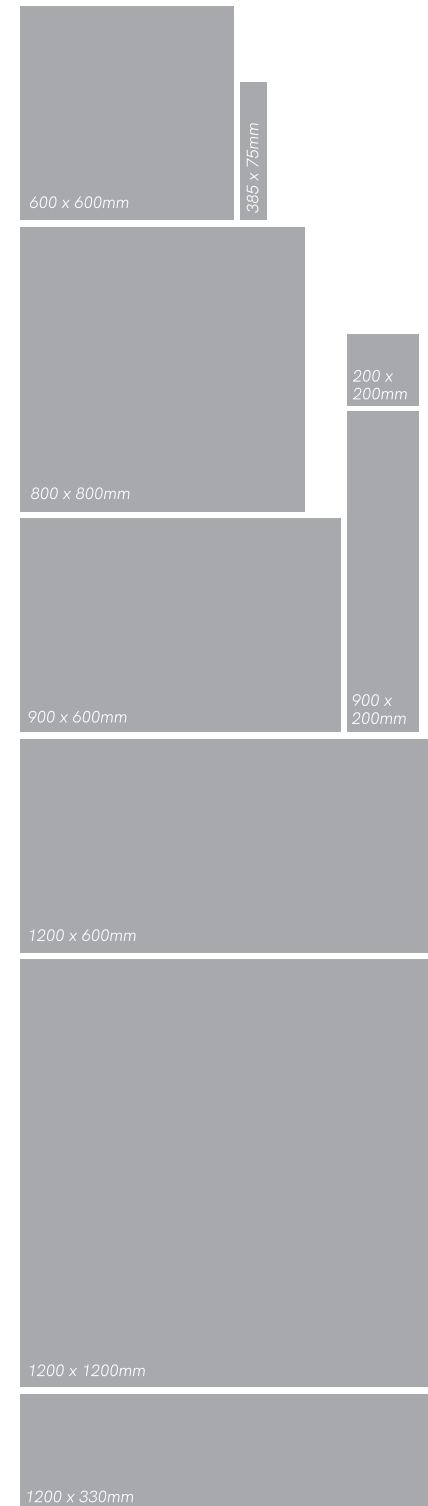

PRINT PATTERNS

Our ranges of porcelain will each contain a number of print patterns, with some containing more than others. The more patterns within a range, the less likely you will be to see repeats within the installation, giving a more natural, blended look.

The below shows an example of various print patterns that can be found within a range.



For further great pre-purchase tips and post-installation care and advice, we strongly recommend you continue your research by reading our handy online guides.





Installation

The Pavetuf range provides a wide choice of installation and maintenance accessories designed to support you with the installation and aftercare of your landscaping products.

We recommend that Vitripiazza is always installed using Pavetuf Priming Slurry. For joints, Pavetuf Jointing Grout is ideal and is designed specifically for use with Vitripiazza products. Pavetuf Jointing Compound can also be used for many applications.



Scan to go to the Knowledge Hub



Adjustable Risers and Decorative Channel Drains are also available to assist with installation and add those finishing touches.

See the full Pavetuf range on page 126.

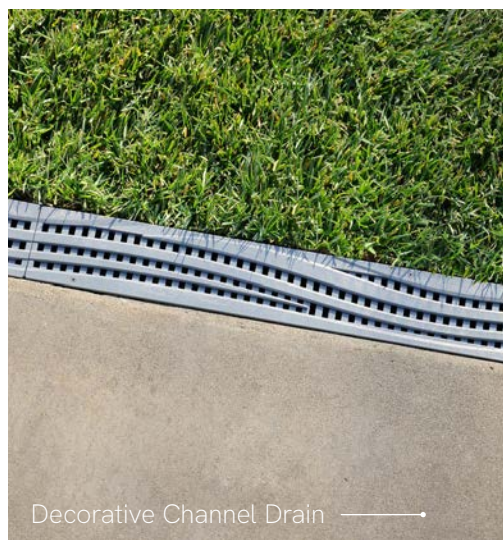

Decorative Channel Drain



Aftercare

The cleaning and maintenance of our Vitripiazza products is easy due to their high resistance to staining.

Our comprehensive range of Pavetuf specialist cleaners makes cleaning even the most stubborn stains easy, check out our range of Pavetuf Cleaners on page 140.



NATURAL STONE

NATURALLY MORE BEAUTIFUL
 ETHICALLY SOURCED STONE PAVING

Talasey's stone range, Natural Paving, offers a wide selection of natural stone landscaping products designed for gardens and driveways, each of which presents a choice of colour, finish and style, providing something to suit every project, home and budget.

We are proud to offer high quality natural stone paving and accessories which have been ethically sourced.



Why choose Natural Paving?

ETHICALLY SOURCED	DURABLE AND FROST RESISTANT
VARIOUS APPLICATIONS	SIMPLE TO MAINTAIN
EASY TO CLEAN	WILL AGE AND IMPROVE IN APPEARANCE OVER TIME
A UNIQUE NATURAL BEAUTY WITH VARIOUS BLENDS OF COLOURS AND TONES	

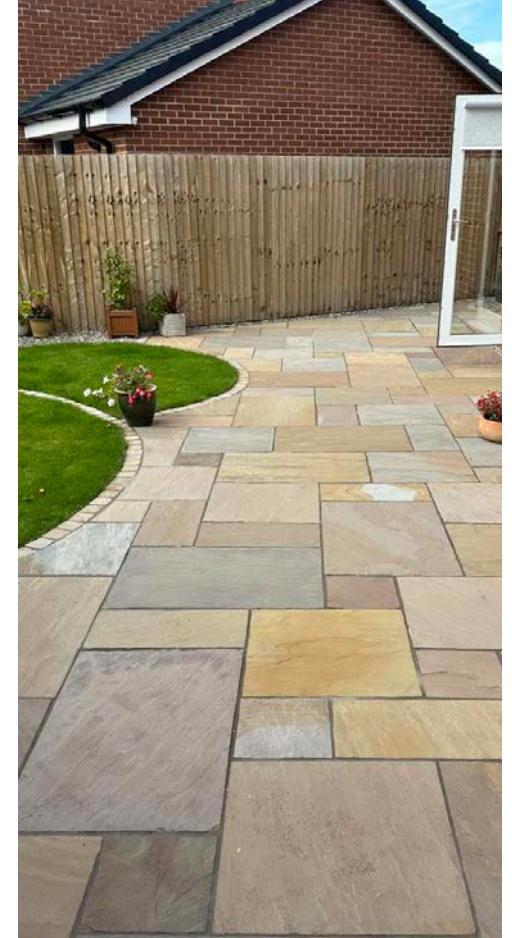

Classicstone, Harvest

What our customers say...

Natural Stone is a fantastic choice of paving with its unique patterns, textures and tones. It works well in almost any outdoor space with its blend of aesthetics, functionality and versatility. We choose to specify Talasey's Natural Paving range, as having a trusted supplier of high quality, ethically sourced natural stone products is important to us.

- Marc Murray,
 Murray Landscapes

PREMIASTONE



Ivory

Premiastone

£££

The Premiastone collection offers a range of prestigious flagstones that have undergone various processes to give them a contemporary and high-end finish.

From cool greys to warm buffs, this premium collection of natural stone landscaping products offers a stunning array of colours in single sizes and project packs.

SANDSTONE

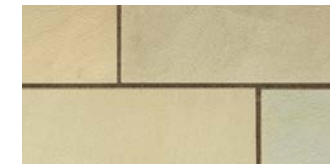

Cornsilk

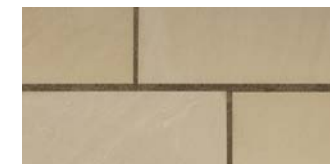

Ivory



York Mix Flamed

SLATE



Black



Grey

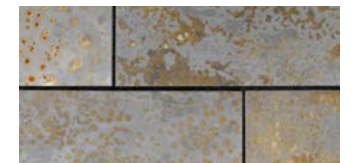

Copper

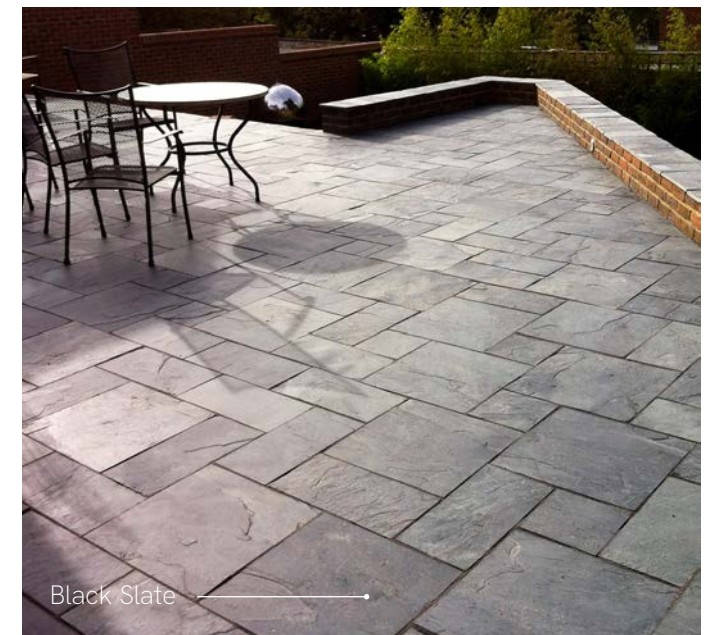

Black Slate



Cornsilk

Cornsilk

Cornsilk is a lightly blasted, textured sandstone with uplifting light tones and occasional natural veining.

Single Size Pack

- 900x600mm
- Thickness: 20mm
- Coverage: 18.00m²
- Weight: 1100kg
- Contains: 32 pieces

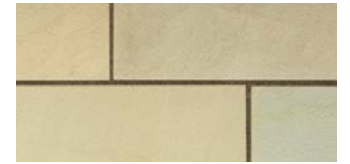

Cornsilk

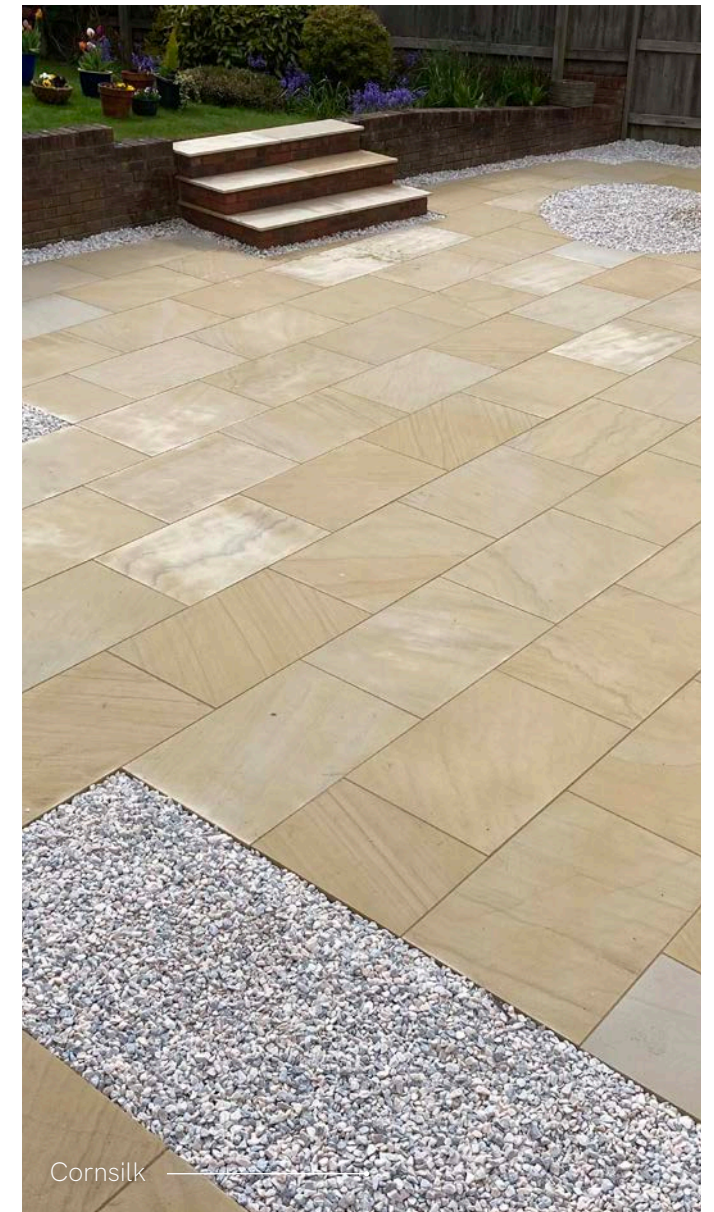

Cornsilk

Ivory

Ivory is a sawn cut and smooth sandstone. This uniquely formed project pack brings a warm colour palette to any outdoor space.

Project Pack Size

400x400mm x 50
600x400mm x 50
Thickness: 20mm
Coverage: 20.36m²
Weight: 1050kg
Contains: 100 pieces

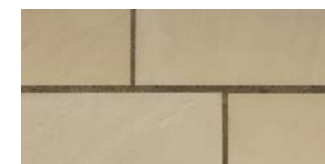

Ivory



Ivory



Ivory

York Mix Flamed

Containing a striking mix of buff, brown and grey tones, York Mix Flamed is a contemporary sandstone with clean edges and a flamed surface, providing an enriched texture.

Single Size Pack

900x600mm
Thickness: 20mm
Coverage: 18.00m²
Weight: 1100kg
Contains: 32 pieces



York Mix Flamed



York Mix Flamed



York Mix Flamed

Slate

A collection of beautiful Brazilian slate products, all of which present a rich choice in terms of quality, feel and aesthetics. From a vibrant copper to a more subdued black or grey, our range of Slates are available in contemporary single sizes, and more traditional project packs.

Project Pack Size

600x600mm x 24
 600x295mm x 35
 295x295mm x 34
 Thickness: 20mm
 Coverage: 18.80m²
 Weight: 980kg
 Contains: 93 pieces

Single Size Packs

1200x600mm
 Thickness: 20mm
 Coverage: 14.40m²
 Weight: 800kg
 Contains: 20 pieces

900x600mm
 Thickness: 20mm
 Coverage: 18.00m²
 Weight: 985kg
 Contains: 32 pieces



Grey

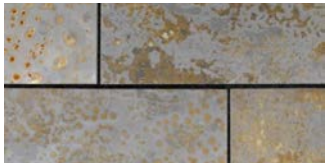

Copper



Black



Copper
 (Product shown wet)



Black



Grey



Copper

CRAGSTONE



Cragstone

££

The Cragstone collection offers a select range of antiqued flagstones, full of warmth and inspired charm. Each piece of stone within the collection has been tumbled to soften the edges and surface, and then calibrated to give a consistent, nominal thickness.

Our cool toned Old York provides a grey and brown colour palette, similar to shades found in the popular 'York Stone', whilst Tuscan brings a rustic warmth to paved areas.

SANDSTONE

LIMESTONE



Old York

Tuscan

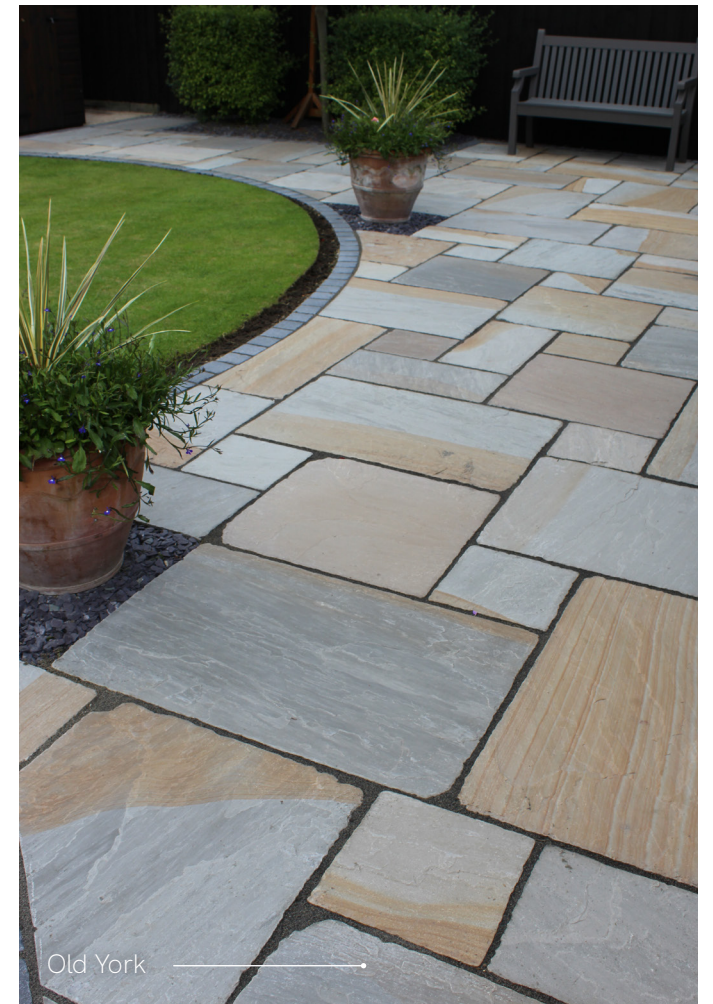

Old York

Tuscan



Old York

Old York sandstone has the colouring of the distinctive 'York Stone' with buff, brown and grey tones and is antiqued to give the same traditional feel of 'York Stone' too.

Project Pack Size

900x600mm x 16
 600x600mm x 16
 600x290mm x 16
 290x290mm x 12
 Thickness: 24mm
 Coverage: 18.90m²
 Weight: 950kg
 Contains: 60 pieces



Old York



Old York

Old York

Tuscan

Tuscan limestone has a subtle antique appearance with a varying colour palette. Rustic with occasional veining, the odd imperfect corner only adds to Tuscan's charming character.

Project Pack Size

900x600mm x 16
 600x600mm x 16
 600x290mm x 16
 290x290mm x 12
 Thickness: 24mm
 Coverage: 18.90m²
 Weight: 950kg
 Contains: 60 pieces



Tuscan



Tuscan



Tuscan



Classicstone

Classicstone is exactly what it suggests, the ultimate in timeless, traditional flagstones. Each hand-cut piece has a naturally riven surface and edges that inspire a warm and natural look. Each flagstone has been hand split to give a unique, riven surface and is calibrated to create a nominal thickness.

HANDSPLIT | HAND DRESSED

SANDSTONE



Harvest



Lakeland



Promenade



Golden Fossil



Graphite



Autumn Brown



Yorkshire Blend

LIMESTONE



Steel Blue



Harbour Grey



Carbon Black



Circle Kits

Promenade

See more on our website





Harvest

Harvest is a traditionally riven sandstone with a variety of colour blends and product sizes.



Harvest

Project Pack Size

900x600mm x 17	Thickness: 18mm	900x600mm x 16	Thickness: 24mm
600x600mm x 20	Coverage: 22.20m ²	600x600mm x 16	Coverage: 18.90m ²
600x290mm x 20	Weight: 950kg	600x290mm x 16	Weight: 950kg
290x290mm x 18	Contains: 75 pcs	290x290mm x 12	Contains: 60 pcs

Single Size Packs

900x600mm	18mm	24mm	600x290mm	18mm	24mm
Coverage:	17.80m ²	17.80m ²	Coverage:	17.80m ²	17.80m ²
Weight:	800kg	925kg	Weight:	800kg	925kg
Contains:	33 pcs	33 pcs	Contains:	102 pcs	102 pcs
600x600mm	18mm	24mm	290x290mm	18mm	24mm
Coverage:	18.00m ²	15.80m ²	Coverage:	19.70m ²	19.70m ²
Weight:	800kg	825kg	Weight:	900kg	1025kg
Contains:	50 pcs	44 pcs	Contains:	232 pcs	232 pcs



Jumbo Size Packs
 1800 x 900mm
 Thickness: 50mm
 Coverage: 12.96m²
 Weight: 1800kg
 Contains: 8 no. pieces

Harvest

Harvest



Lakeland

Lakeland

Lakeland sandstone is a best seller from the Classicstone range, finding its way into many gardens along with a range of complementary Lakeland accessories.



Lakeland

Project Pack Size

900x600mm x 17	Thickness: 18mm	900x600mm x 16	Thickness: 24mm
600x600mm x 20	Coverage: 22.20m ²	600x600mm x 16	Coverage: 18.90m ²
600x290mm x 20	Weight: 950kg	600x290mm x 16	Weight: 950kg
290x290mm x 18	Contains: 75 pcs	290x290mm x 12	Contains: 60 pcs

Single Size Packs

900x600mm	18mm	24mm	600x290mm	18mm	24mm
Coverage:	17.80m ²	17.80m ²	Coverage:	17.80m ²	17.80m ²
Weight:	800kg	925kg	Weight:	800kg	925kg
Contains:	33 pcs	33 pcs	Contains:	102 pcs	102 pcs
600x600mm	18mm	24mm	290x290mm	18mm	24mm
Coverage:	18.00m ²	15.80m ²	Coverage:	19.70m ²	19.70m ²
Weight:	800kg	825kg	Weight:	900kg	1025kg
Contains:	50 pcs	44 pcs	Contains:	232 pcs	232 pcs



Lakeland



Promenade

Promenade

A classic sandstone with a cool colour palette, Promenade offers a predominantly grey hue, but can also contain attractive brown and buff shades.



Promenade

Project Pack Size

900x600mm x 17	Thickness: 18mm	900x600mm x 16	Thickness: 24mm
600x600mm x 20	Coverage: 22.20m ²	600x600mm x 16	Coverage: 18.90m ²
600x290mm x 20	Weight: 950kg	600x290mm x 16	Weight: 950kg
290x290mm x 18	Contains: 75 pcs	290x290mm x 12	Contains: 60 pcs

Single Size Packs

900x600mm	18mm	24mm	600x290mm	18mm	24mm
Coverage:	17.80m ²	17.80m ²	Coverage:	17.80m ²	17.80m ²
Weight:	800kg	925kg	Weight:	800kg	925kg
Contains:	33 pcs	33 pcs	Contains:	102 pcs	102 pcs
600x600mm	18mm	24mm	290x290mm	18mm	24mm
Coverage:	18.00m ²	15.80m ²	Coverage:	19.70m ²	19.70m ²
Weight:	800kg	825kg	Weight:	900kg	1025kg
Contains:	50 pcs	44 pcs	Contains:	232 pcs	232 pcs

Jumbo Size Packs

1800 x 900mm
 Thickness: 50mm
 Coverage: 12.96m²
 Weight: 1800kg
 Contains: 8 no. pieces

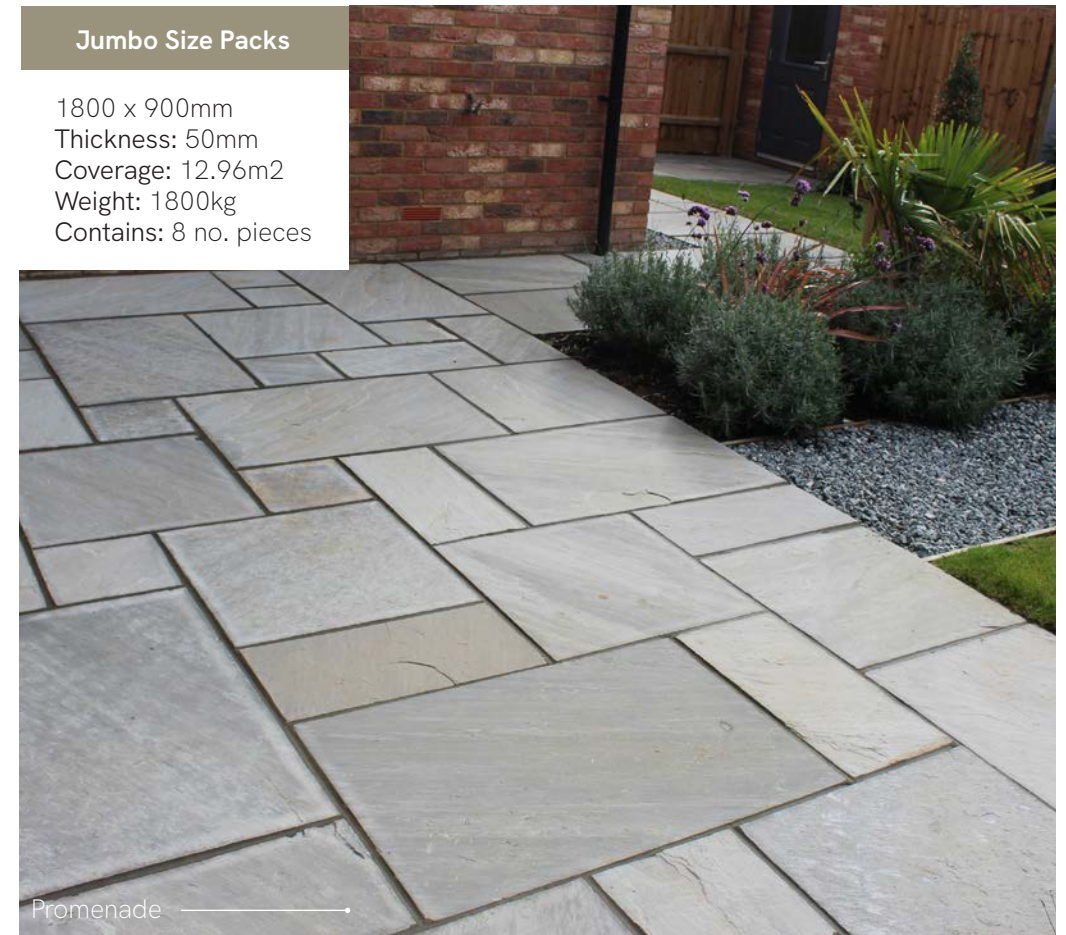

Promenade



Golden Fossil

This riven sandstone showcases a light colour palette featuring some darker shades and occasional carbon imprint fossil patterns.



Golden Fossil

Project Pack Size

900x600mm x 16
 600x600mm x 16
 600x290mm x 16
 290x290mm x 12
 Thickness: 24mm
 Coverage: 18.90m²
 Weight: 950kg
 Contains: 60 pieces

Single Size Packs

900x600mm
 Thickness: 24mm
 Coverage: 17.80m²
 Weight: 925kg
 Contains: 33 pieces

600x600mm
 Thickness: 24mm
 Coverage: 15.80m²
 Weight: 825kg
 Contains: 44 pieces

600x290mm
 Thickness: 24mm
 Coverage: 17.80m²
 Weight: 925kg
 Contains: 102 pieces

290x290mm
 Thickness: 24mm
 Coverage: 19.70m²
 Weight: 1025kg
 Contains: 232 pieces



Golden Fossil

Golden Fossil



Graphite

Graphite is a sandstone product with a rustic riven surface featuring contrasting dark and light shades.

Project Pack Size

900x600mm x 16
 600x600mm x 16
 600x290mm x 16
 290x290mm x 12
 Thickness: 24mm
 Coverage: 18.90m²
 Weight: 950kg
 Contains: 60 pieces



Graphite



Graphite

Graphite



Autumn Brown

Autumn Brown is a traditional sandstone with a riven surface and irregular interesting edges.

Project Pack Size

900x600mm x 17	Thickness: 18mm
600x600mm x 20	Coverage: 22.20m ²
600x290mm x 20	Weight: 950kg
290x290mm x 18	Contains: 75 pcs

900x600mm x 16	Thickness: 24mm
600x600mm x 16	Coverage: 18.90m ²
600x290mm x 16	Weight: 950kg
290x290mm x 12	Contains: 60 pcs



Autumn Brown



Autumn Brown

Autumn Brown

See more on
our website



Yorkshire Blend

Yorkshire Blend

Yorkshire Blend is a traditional sandstone with a naturally riven finish, displaying a similar colour palette to the distinctive 'York Stone'.

Project Pack Size

900x600mm x16
600x600mm x16
600x290mm x16
290x290mm x12
Thickness: 24mm
Coverage: 18.90m²
Weight: 950kg
Contains: 60 pieces



Yorkshire Blend



Yorkshire Blend



Steel Blue

Steel Blue

Steel Blue is a traditional hand-cut limestone, with a riven surface. As with all limestone products, Steel Blue will naturally lighten overtime.

Project Pack Size

- 900x600mm x16
- 600x600mm x16
- 600x290mm x16
- 290x290mm x12
- Thickness: 24mm
- Coverage: 18.90m²
- Weight: 950kg
- Contains: 60 pieces



Steel Blue

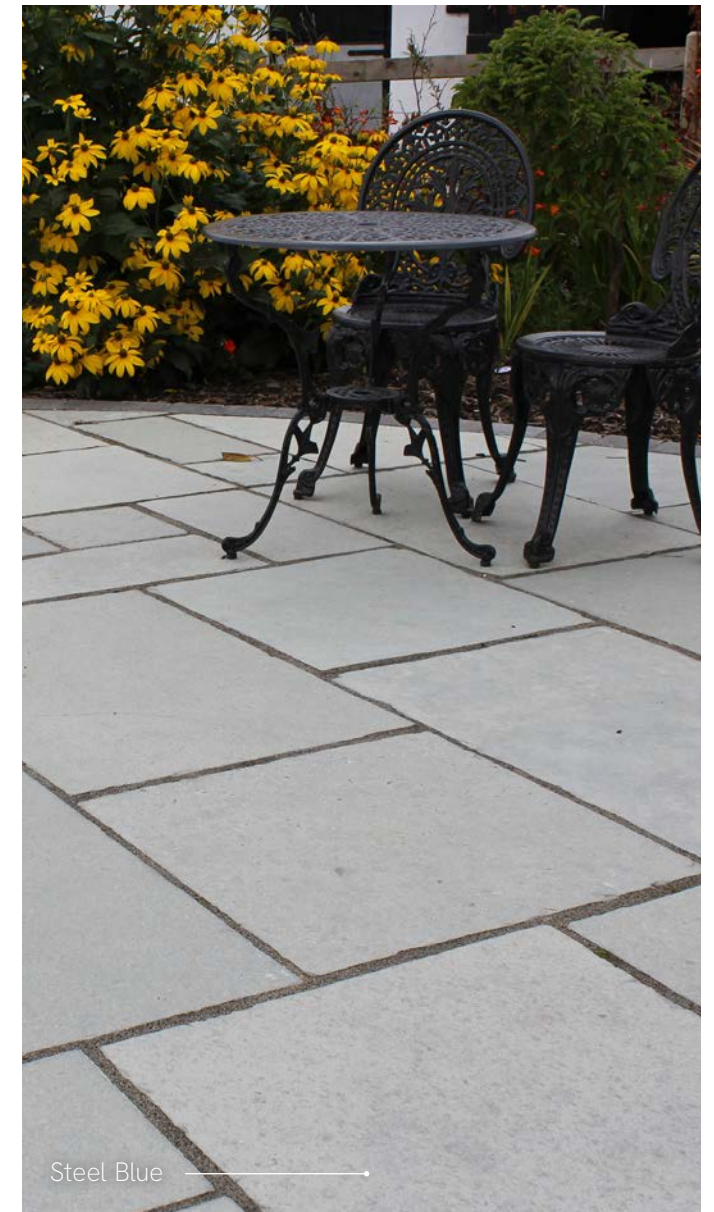

Steel Blue

Harbour Grey

Harbour Grey is a limestone with a sleek, sawn edge featuring a colour palette of mixed grey tones. As Harbour Grey is a limestone, it will naturally lighten over time.

Project Pack Size

900x600mm x16
 600x600mm x16
 600x290mm x16
 290x290mm x12
 Thickness: 24mm
 Coverage: 18.90m²
 Weight: 950kg
 Contains: 60 pieces



Harbour Grey



Harbour Grey



Harbour Grey



Carbon Black with Midnight Blue Kerbs and Meadow Cobbles
Sealed with Pavetuf Satin Sealer

Carbon Black

A dark limestone, Carbon Black is a riven, hand-cut stone with a deep colour palette. As a limestone, Carbon Black will naturally lighten over time.

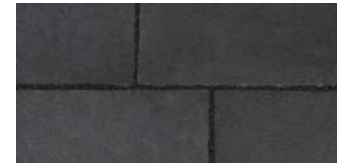

Carbon Black

Project Pack Size

900x600mm x 16
600x600mm x 16
600x290mm x 16
290x290mm x 12
Thickness: 24mm
Coverage: 18.90m²
Weight: 950kg
Contains: 60 pieces

Single Size Packs

900x600
Thickness: 24mm
Coverage: 17.80m²
Weight: 950kg
Contains: 33 pieces

600x600
Thickness: 24mm
Coverage: 15.80m²
Weight: 900kg
Contains: 44 pieces

600x290
Thickness: 24mm
Coverage: 17.80m²
Weight: 950kg
Contains: 102 pieces



Carbon Black
Sealed with Pavetuf Satin Sealer



See more on
our website



Circle Kits

Our Classicstone Circle Kits are ideal for creating features and focal points within your landscape. Available in 4 popular Classicstone colours, each circle kit comes with a squaring off kit, for the perfect finishing touch.

Circle Kit Pack Sizes

Each flag is: 24mm thick

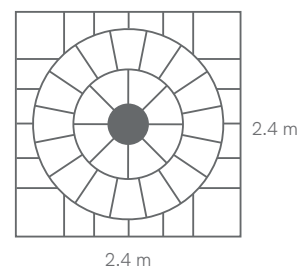

Each pack:
Covers: 5.8m²
Weighs: 325kg
Contains: 45 pcs
Includes squaring off kit

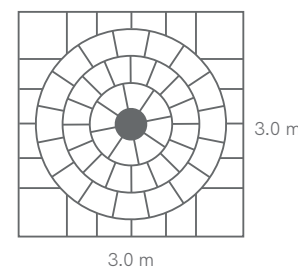

Each pack:
Covers: 9.0m²
Weighs: 475kg
Contains: 61 pcs
Includes squaring off kit



Golden Fossil



Promenade

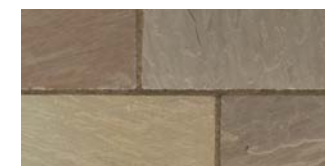

Lakeland



Harvest

Please note on the images shown the installer has chosen to not use the squaring off kit.



Golden Fossil

See more on our website



Lakeland
(Product shown wet)

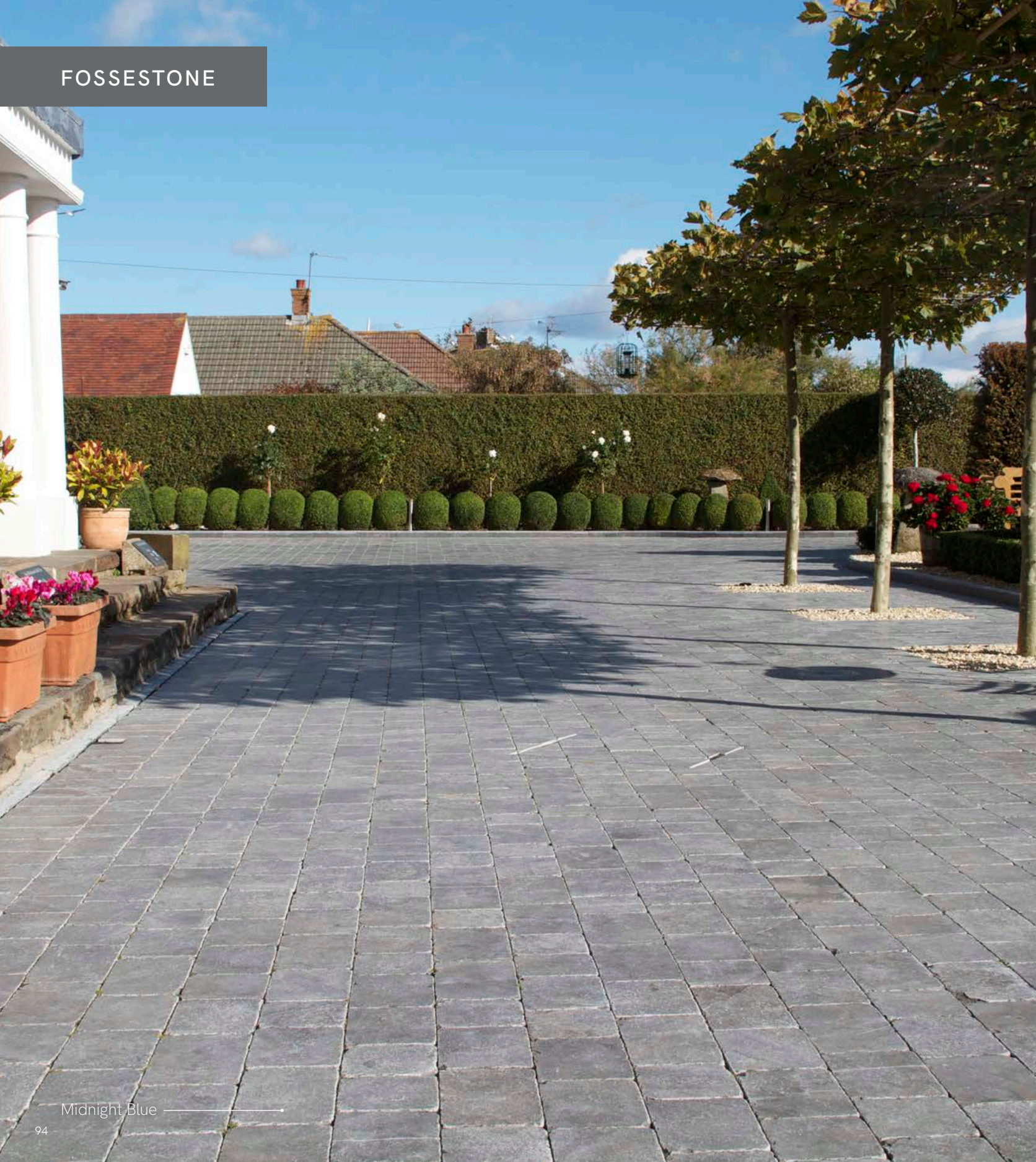

Midnight Blue

Fossestone

Our natural stone block paving provides an attractive solution for driveways due to the durability of the individual blocks. Choose from 5 colours that individually create a stunning finish, or mix and match contrasting borders and areas to create unique designs. All of the blocks are 50mm in depth, however this is a nominal thickness due to the natural, riven nature of the top surfaces, in line with industry standard tolerances.

SANDSTONE



Cinder



Forest



Orchard

LIMESTONE



Ebony



Midnight Blue



See more on our website



Forest



Cinder

Cinder

Cinder is an antiqued, riven block paver with a varying palette of brown, buff and grey tones.

Project Pack Size

- 150x150mm x 56
- 200x150mm x 80
- 250x150mm x 128
- Thickness: 50mm
- Coverage: 8.50m²
- Weight: 1200kg
- Contains: 264 pieces



Cinder

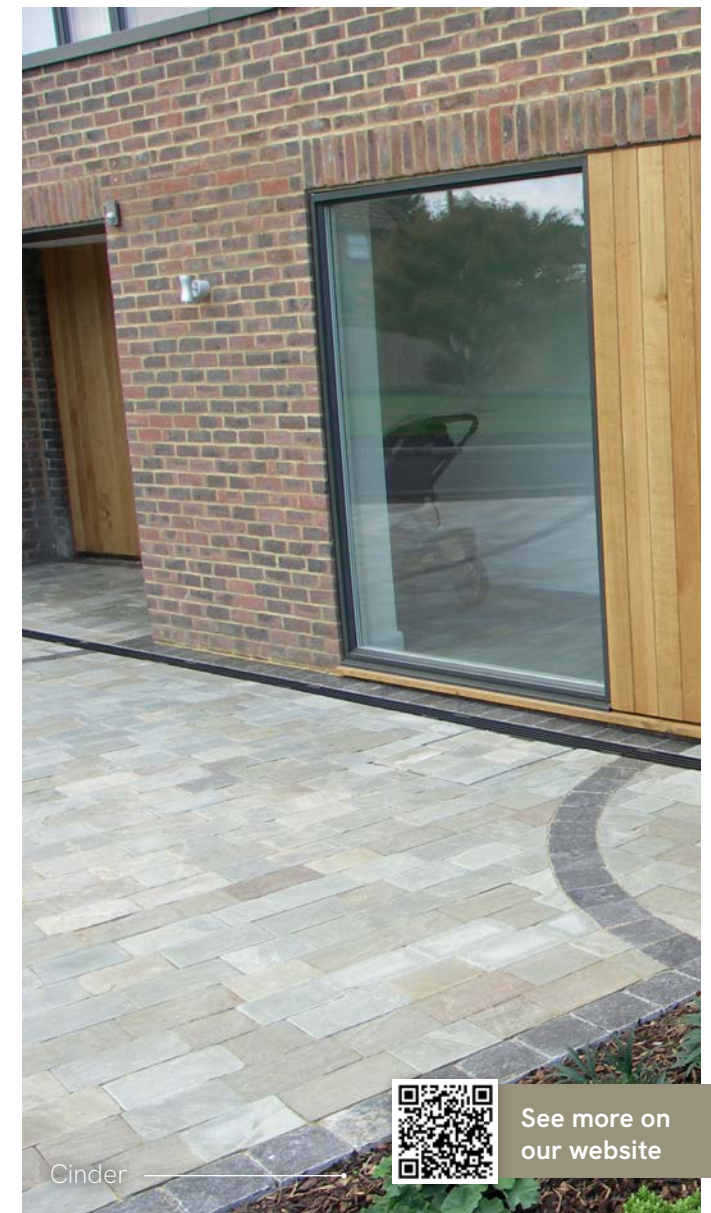

Cinder



See more on
our website



Forest with Midnight Blue Edge

Forest

Forest is a tumbled and antiqued sandstone product with a riven surface and a range of complementing warm tones.

Project Pack Size

- 150x150mm x 56
- 200x150mm x 80
- 250x150mm x 128
- Thickness: 50mm
- Coverage: 8.50m²
- Weight: 1200kg
- Contains: 264 pieces



Forest

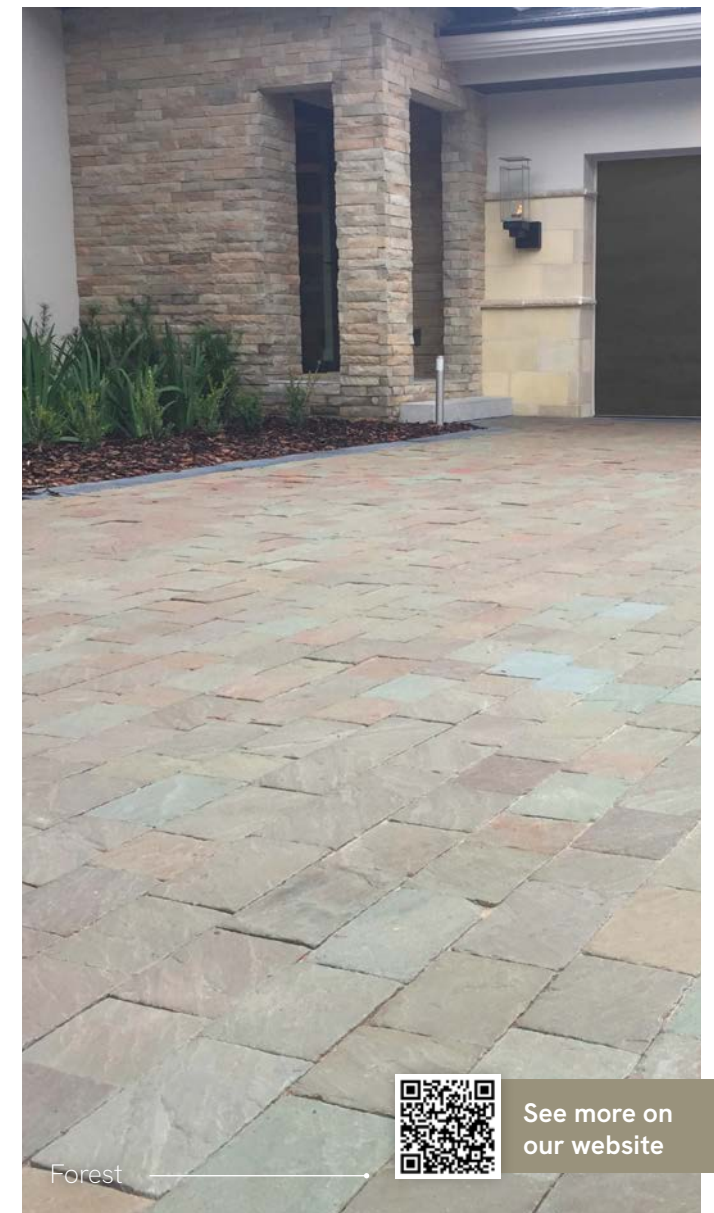

See more on our website

Forest

Orchard

Orchard is a sandstone block paver that has a natural riven surface and is lightly tumbled to give an antiqued look.

Project Pack Size

- 150x150mm x 56
- 200x150mm x 80
- 250x150mm x 128
- Thickness: 50mm
- Coverage: 8.50m²
- Weight: 1200kg
- Contains: 264 pieces



Orchard



Orchard with Midnight Blue Stretcher Course



Orchard



Midnight Blue

Midnight Blue

Midnight blue is a stunning blue limestone block paver, that works well on it's own, or as a contrasting border or stretcher course.

Single Size Packs

250x150mm
Thickness: 50mm
Coverage: 8.40m²
Weight: 1150kg
Contains: 224 pieces



Midnight Blue

200x150mm
Thickness: 50mm
Coverage: 8.40m²
Weight: 1150kg
Contains: 280 pieces

Also available in a complementary kerb, see page 117 for details.

150x150mm
Thickness: 50mm
Coverage: 8.80m²
Weight: 1150kg
Contains: 392 pieces



See more on our website



Midnight Blue



Ebony

Ebony

Ebony is a dark tumbled limestone product with 4 sawn edges and a naturally riven surface. This block paver offers a traditional feel with a contemporary colour. As Ebony is a limestone, it will naturally lighten over time.

Single Size Pack

- 250x150mm
- Thickness: 50mm
- Coverage: 8.40m²
- Weight: 1150kg
- Contains: 224 pieces

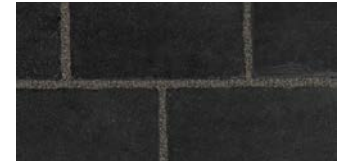

Ebony

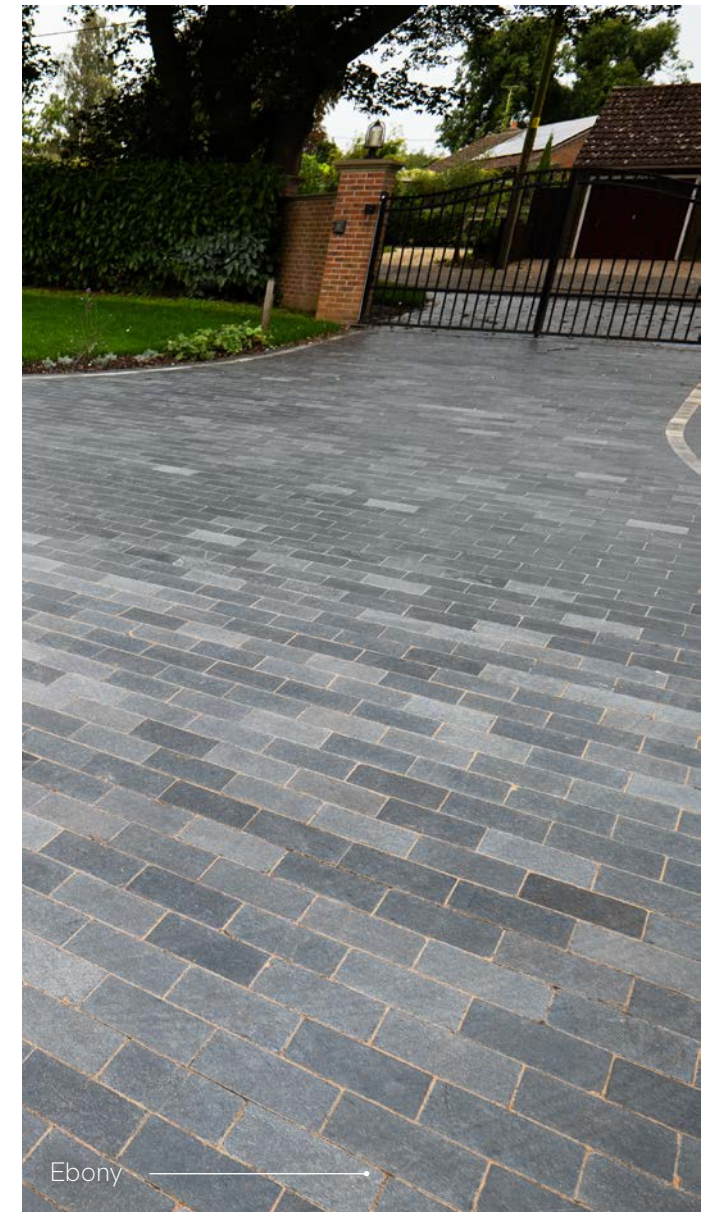

Ebony

COBBLESTONE

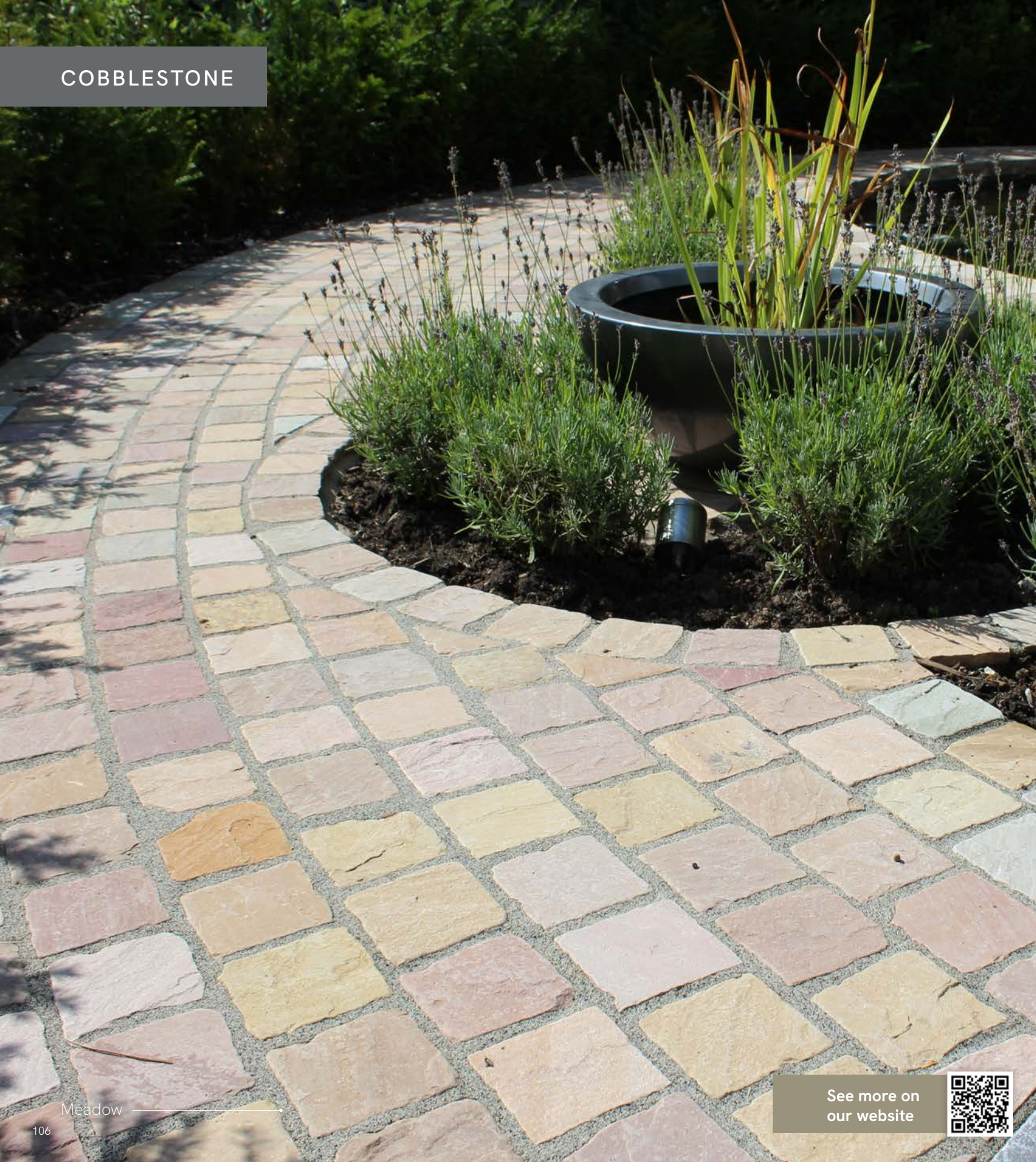

Meadow

See more on our website



Cobblestone

The Cobblestone collection offers a range of versatile, charming and stylish products to accessorise any part of your garden.

WEATHERED COBBLES

SILVER SETTS



Meadow



Calico



Granite Silver



Pewter



Ebony

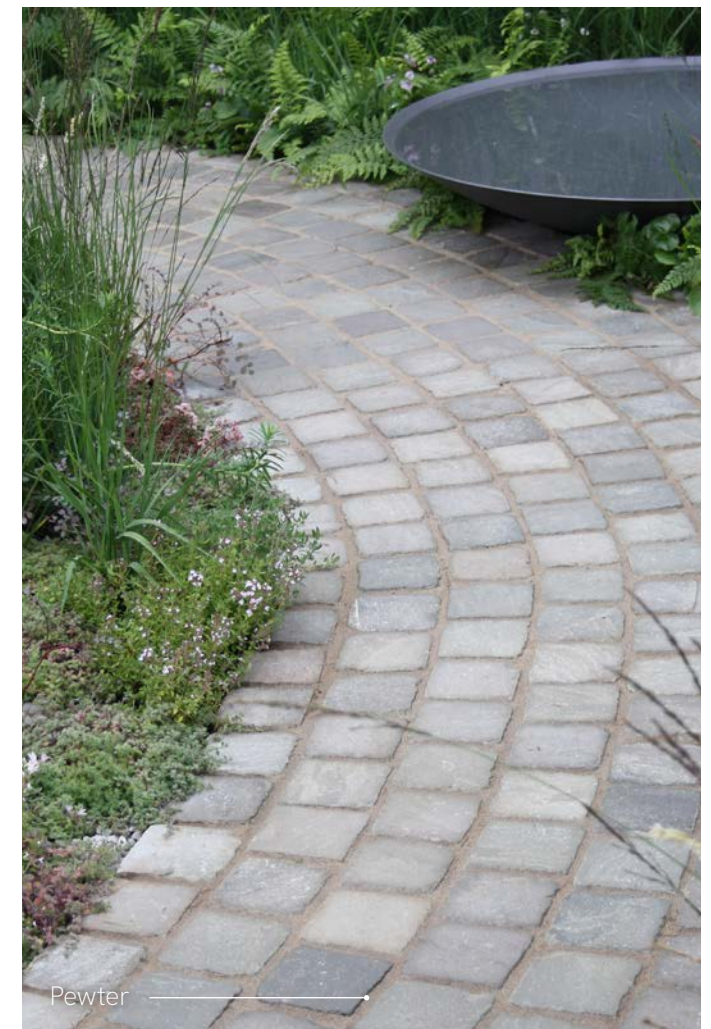

Pewter

Weathered Cobbles

Our Weathered Cobbles are naturally split with an antique finish, ideal for cottage style courtyards and traditional settings. The collection includes 4 colour options, each of which can be used in a variety of applications including patios, paths, driveways and courtyards.

Project Pack Size

100x150mm x 195
 150x150mm x 195
 200x150mm x 195
 Thickness: 25-50mm
 Coverage: 15.00m²
 Weight: 1100kg
 Contains: 585 pieces

Single Size Packs

100x100mm
 Thickness: 25-50mm
 Coverage: 6.00m²
 Weight: 500kg
 Contains: 500 pieces

200x100mm*
 Thickness: 25-50mm
 Coverage: 6.00m²
 Weight: 500kg
 Contains: 250 pieces

**Only available in Ebony
 Please note if you wish
 cobbles to take vehicular
 traffic, they must be laid on
 a full bed of mortar and
 we recommend the use of
 a priming slurry and a
 strong jointing mortar.*

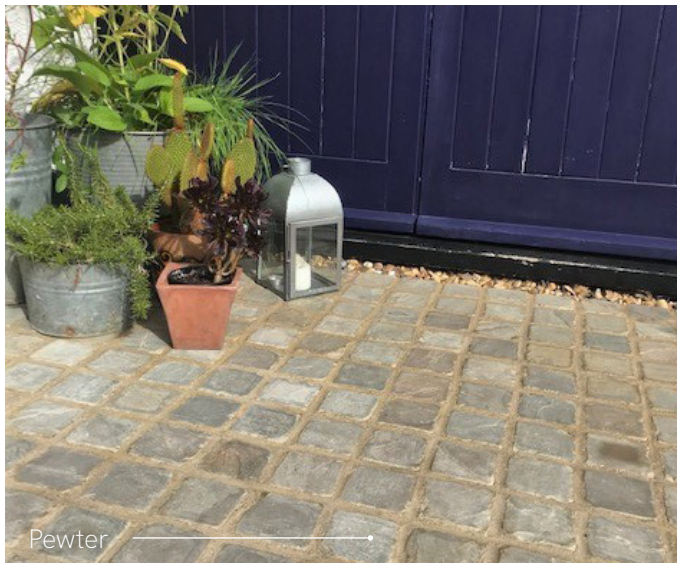

Meadow



Pewter



Calico



Ebony



Granite Silver with Ebony Fossestone

Silver Setts

Our traditional Granite Setts are fantastic for creating a rustic feel and will give your courtyard space an impressive finish. With a versatile edge, the Granite Setts can also be used with contemporary products, to create an on-trend garden or bespoke feature.

Single Size Packs

100x100mm
 Thickness: 80-100mm
 Coverage: Approx. 5-6m²
 Weighs: 1000kg
 Contains: Approx. 400-500 pieces

200x100mm
 Thickness: 80-100mm
 Coverage: Approx. 5-6m²
 Weighs: 1000kg
 Contains: Approx. 200-250 pieces



Granite Silver

Please note: Silver Setts are sold in 1000kg crates. Depending on the thickness of the setts, the number per crate will vary.



Granite Silver

STONE ACCESSORIES



Promenade Fire Pit

See more on
our website



Stone Accessories

To really finish off your hard landscaping with design and flair, look no further than the Natural Paving range of accessories. Choose from natural stone walling, copings and fire pits to really add those finishing touches to your project, available in a choice of complementary colours to suit any desired aesthetic.

WALLING | COPINGS | FIRE PITS | KERBS



Platinum Flamed, Bullnose

Cottagestone Walling

Cottagestone Walling is available in Golden Fossil, Lakeland and Carbon Black. Our multi-purpose walling blocks can be installed to show either their pitched or riven face, for a different effect.

Riven Face: Derived from a natural split on the stone, conveying a traditional look.

Pitched Face: A hand chiselled unique aged effect.

Mixed Size Pack

- 200x100mm x75
- 300x100mm x75
- 365x100mm x75

Thickness: 50-75mm when laid pitched face, 100mm when laid riven face.

Coverage: 5.00m² when laid pitched face, 7.50m² when laid riven face

Weighs: 1100kg

Contains: 225 pieces

As Carbon Black is a limestone, it will naturally lighten over time. Please note that time should be taken to course the blocks prior to installation.



Carbon Black



Golden Fossil



Lakeland



Carbon Black



Golden Fossil

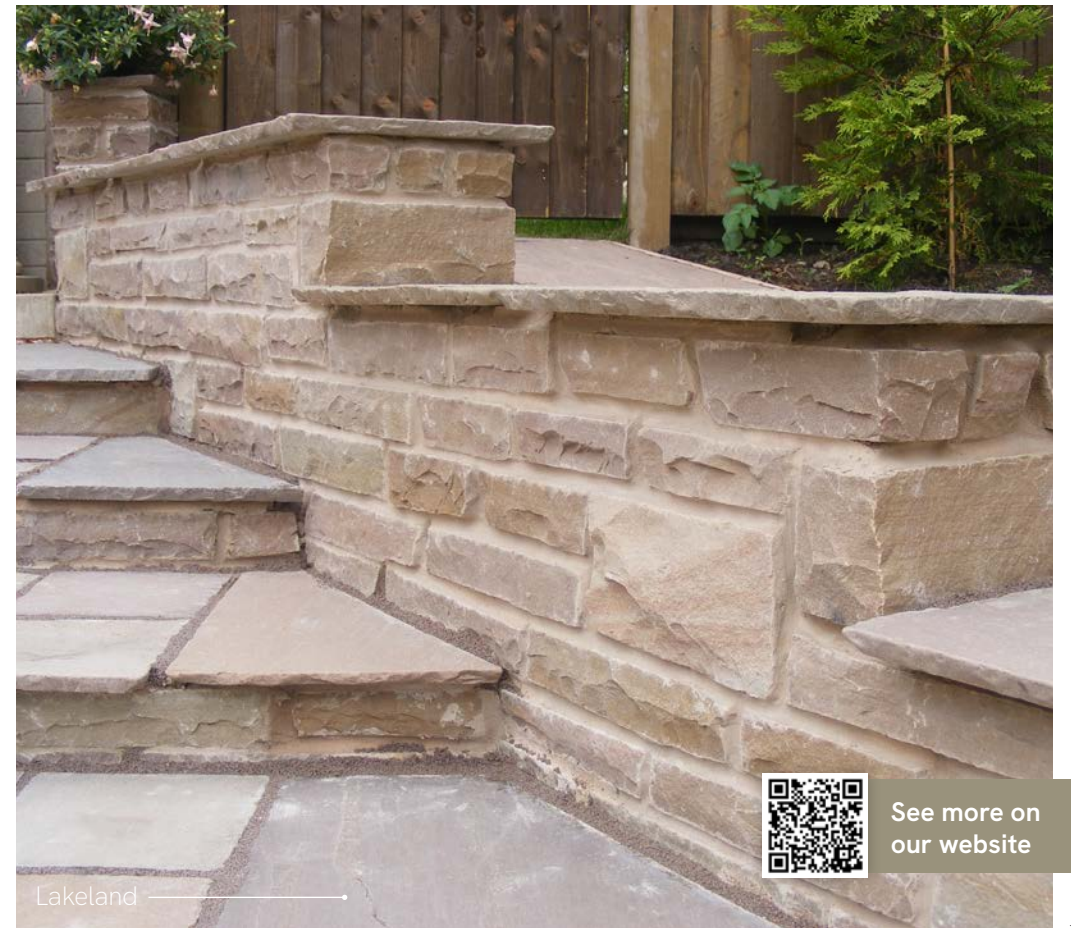

Lakeland



See more on our website



Cornsilk

Copings

Our versatile coping products have been designed for use as steps, pool copings and wall copings, enabling a consistent finish to be created within any designed landscape project. Available in a choice of complementary colour and finishes, our range of copings allow you to add the perfect finishing touches to your landscaped area.

Single Size Pack





600x300mm
Thickness: 50mm
Coverage: 7.20
linear metres
Weights: 250kg
Contains: 12 pieces

Bullnosed along one side (600mm) edge only. If you require a bullnose on both edges, please contact us

Colours with a lightly textured surface:

-  Cornsilk
-  Platinum Flamed

Colours with a naturally riven surface:

-  Carbon Black
-  Promenade
-  Golden Fossil
-  Lakeland

Carbon Black

See more on
our website



Kerbs

To give your driveway and garden a natural edge over all others, try our Midnight Blue Limestone Kerbs, ideal as borders to patios and driveways.

Please note, as Midnight Blue is a limestone, it will naturally lighten over time.

Single Size Pack

180x120x100mm
Each pack:
Linear: 12.50m
Weights: 750kg
Contains: 125 pieces



Midnight Blue

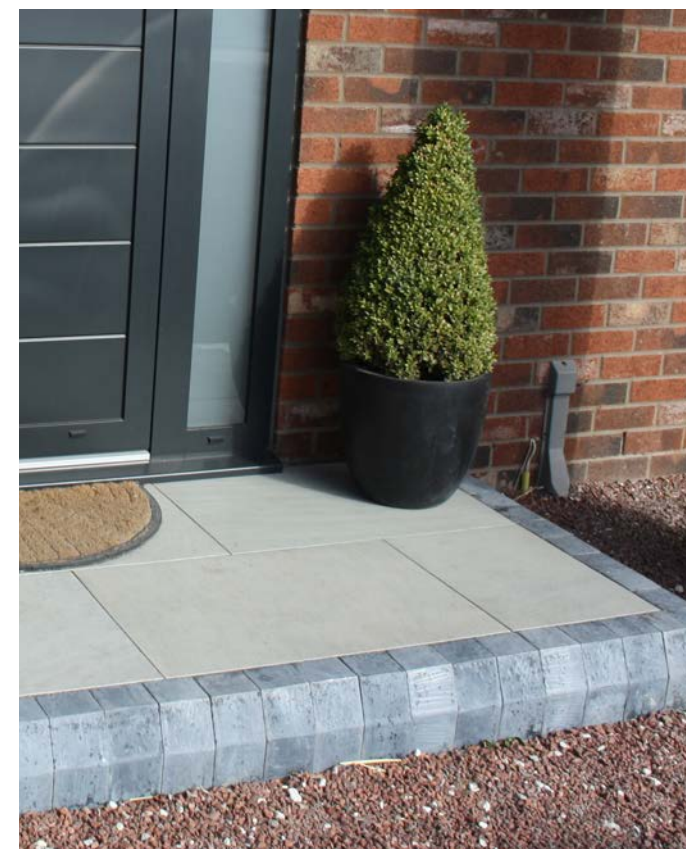

Fire Pits

Not only do our fire pits create beautiful focal points, but they are functional allowing you to enjoy your outdoor space for longer throughout the cooler seasons and are great for those social occasions that go on into the evening. Our fire pits are pre-made, hand-cut and come in simple to assemble kits. Available in a choice of two colours, Lakeland and Promenade.

Mixed Size Pack

Internal Diameter: 927mm
External Diameter: 1454mm
Height: 430mm
Weights: 1060kg
Contains: 59 pieces

50 Walling pieces: approximately 404x200x75mm
The top, bottom and sides are sawn and the face is chiselled

9 Coping pieces: approximately 492x260x50mm
They have a natural riven top with a sawn bottom and sides and the face is chiselled.

Colours:
Promenade
Lakeland

Please note the fire pit surround should be either lined with steel or rendered in fireproof cement before use.



Lakeland



See more on our website

Fire Pit Insert

Enjoy a reduced-smoke, wood burning fire pit that is suitable to insert into our Natural Paving range of fire pits or alternatively used as a stand-alone fire pit.

The double wall construction with bottom vent holes for oxygen creates an internal airflow circulation system. This cutting edge "afterburn" technology injects air into the top of the fire creating a reduced-smoke burn.

Please note fire pit insert will change in colour once exposed to heat.



Heat Deflector

Our Heat Deflectors redirect the heat for more fireside warmth, magnifying the heat radius. As hot air rises and scatters, the Heat Deflector captures and redirects the warmth to where you need it most. The precision-angle center cone is designed to tame the heat so you can easily find fireside comfort.



Lakeland



Promenade

Considerations

Install

We offer a range of products designed to aid the construction and installation of our natural stone products, including Jointing Compound and Priming Slurry. Please see our range of Pavetuf specialist products for more information on page 126.

Protect & Maintain

Protect and maintain your paving with our range of Pavetuf Sealants to help both minimise the need for maintenance and to enhance the appearance, without affecting the natural beauty that first attracted you. We also offer a wide choice of specialist cleaners, that can tackle everyday cleaning to specific stain types. Visit page 140 to learn more.



For further great pre-purchase tips and post-installation care and advice, we strongly recommend you continue your research by reading our handy online guides.

Product Measurements

All product sizes, weights and coverages stated throughout this brochure are nominal and subject to product specific tolerances.

Colour Banding

Due to the nature of the product and potential colour variations, we recommend mixing product from all packs on-site, to prevent colour banding. We strongly recommend you purchase all the crates you require for your project at once, to avoid any batch variation.

Cost

When it comes to considering the cost of the product range you choose we have added simple symbols to assist you in your choice. Consider that 80% of the cost of a project is made up of the base elements and installation underneath that you do not see. The paving actually only forms 20% of the overall cost, so choosing a premium quality paving will not significantly add to the overall project costs.

Colour and Surface Variations

Natural stone products are uniquely formed through geological processes, making each piece of stone characteristically subject to colour variations, veining, markings and occasional charming imperfections. As no two pieces are identical, natural stone products offer homeowners a truly bespoke landscaping solution.

Brochure Imagery

The product images are an indicative guide towards the finishes and shade variations that can be represented in any given production batch, but they are not wholly representative. Seeing actual material displays or laid installations are the best way to make your choice. On delivery, we strongly recommend you check the finishes and shades are to your satisfaction prior to installation.

Bespoke Service

Our product offer goes beyond what you see in our brochures, and we encourage you to contact us with any specifications you may have, as we can assist in sourcing alternative sizes, thicknesses and surface finishes to meet your requirements.

We offer a bespoke cutting service, allowing you to create unique patterns and designs for a real 'wow' factor, adding a unique touch to your designs that cannot be found 'off the shelf'.

Our in-house bullnosing allows us to process individual pieces of paving in any of our colour options, with a wide variety of options available.

For something truly personal, why not consider our etching service? We can etch and engrave any pieces of stone and porcelain to your own design!



"The bespoke service allows us to offer our customers those little extra details for that higher-end finish. Turnaround time is extremely quick which helps speed up the installation and the factory finish is of an outstanding quality"

- Lee Pickwell, Pickwell Paving

Menu of bespoke manufacturing & specifications



Etching

To truly personalise your paving we can etch and engrave any pieces to your own design!



Hole cutting

We can cut bespoke holes into individual pieces of paving and decking, to accommodate any outdoor lighting products.



Preformed steps

For preformed steps to match porcelain paved areas, we can cut and bullnose your step treats and also provide a riser to fit the size of your step to batch match your whole project.



Stone specifications

We can tailor natural stone to many size formatted, thicknesses and surface finishes, to meet the needs of bespoke project requirements.



Accessory products

A range of accessory products including step, swimming pool and wall copings.

Edgings

We can edge process and bespoke cut individual pieces of paving in any of our colour options, to complement your project. There are a wide variety of options available!



Bullnose and Drip



Pencil Round



Half Bullnose



Chamfered



Splay



Sharknose

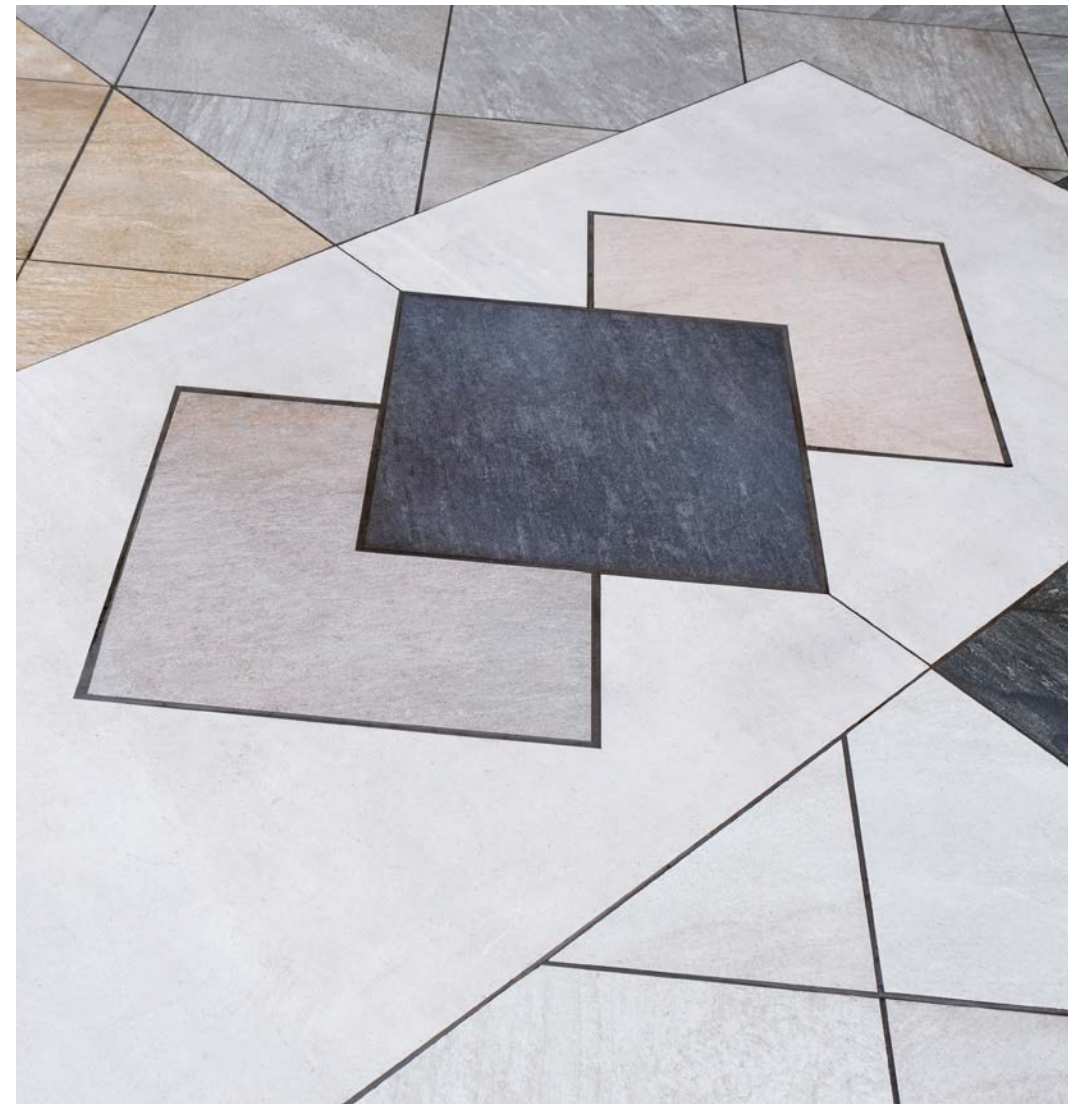

INSTALL MAINTAIN PROTECT

WE'VE GOT YOU COVERED

Talasey's paving installation and maintenance range, Pavetuf[®], is a range of products to enable the installation and maintenance of all your hard landscaping needs.

The Pavetuf range provides the tools and products that you may need to cut, install and join your paving, through to protecting and cleaning it.

SHOP BY RANGE

INSTALL

- Priming Slurry
- Jointing Compound
- Jointing Grout
- Risers
- Edging
- Accessories
- Drainage

MAINTAIN

- Cleaners

PROTECT

- Sealants



Pavetuf, Satin Sealer



Pavetuf, Green Off

What our customers say...

Pavetuf Green-Off was so simple to use and worked a treat! I can't believe how much cleaner my patio looked after just one use!

- Megan, Homeowner



Pavetuf Priming Slurry



Pavetuf Priming Slurry is a polymer and cementitious slurry, specially formulated to provide an exceptional bond between a new mortar base and porcelain or stone paving.

- ★ Quick and easy to use
- 💧 Mix with water
- 🌿 More eco-friendly with reduced carbon

Sizes available

25kg bag
Coverage 19m²
Eco-friendly alternative to the tub option

17kg tub
Coverage 12m²



Pavetuf Priming Slurry has partial replacement of the Ordinary Portland Cement with ground granulated blast-furnace slag which not only provides a saving on CO₂ production but also facilitates environmentally friendly disposal of the waste slag.

How To Use

Using a paddle mixer, mix the slurry powder with fresh water for a minimum of 3 minutes.

1



Using a brush, trowel or roller, apply the slurry onto the back of the flagstone, ensuring the full flag is covered, edge to edge.

2



Lay the flagstone onto the full mortar bed where the slurry will provide an exceptional bond.

3



INSTALL



How to
use guide

Finish off your porcelain, stone and concrete paved areas, using one of our **Pavetuf jointing products**. Please refer to our comparison chart on page 133 to help select the appropriate jointing product for the job.

Pavetuf Jointing Compound

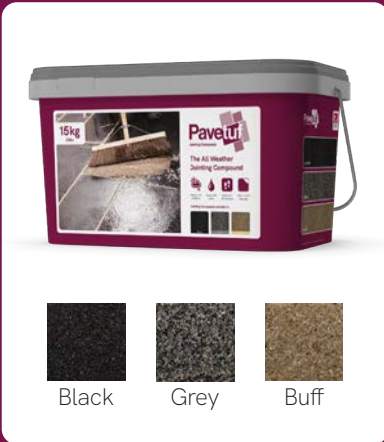

An easy to apply all weather jointing compound.

- ▶ Apply with water, the joints would need to be free draining for this air cured product.
- ▶ Walk on in 24 hours**.
- ▶ Fast and easy to apply in all weathers.
- ▶ No waste, excess product can be stored with water in the tub.
- ▶ Can fill joint widths from 5mm-20mm and joint depths from a minimum of 20mm.
- ▶ Bucket is made from recyclable materials and is fully recyclable.

*Approximately. Coverage based on paving that is 600mm x 600mm, with 20mm deep/10mm wide joints.

**Please refer to our technical guidance for the full details.

Sizes available

15kg tub
Coverage 12m²*



For each tub of Pavetuf Jointing Compound sold, 5p goes to Band of Builders charity.



How To Use

Thoroughly soak the paving and compound - the wetter the better!

1



Brush or squeegee into the joints. Using a pointing iron, compact the joints and top up where necessary.

2



Rinse off any excess compound and leave to cure.

3



How to
use video



How To Use

Mix the Grout powder with clean water to make a paste and stand for 2-3 minutes.

1



Work the Grout into the joints using a trowel, small squeegee or sponge.

2



Leave to set for approx. 30 minutes and then clean the surface with a damp sponge.

3



Pavetuf Jointing Grout



An easy to apply tile grout, ideal for use with Vitripiazza porcelain paving and cladding products.

- ▶ Efflorescence free.
- ▶ Water repellent.
- ▶ For joint widths of 1-15mm.
- ▶ Stain resistant.
- ▶ Rapid Setting**.
- ▶ Can be used both internally and externally.

*Approximately. Coverage based on paving that is 600mm x 600mm, with 20mm deep/5mm wide joints.
**Please refer to our technical guidance for the full details.

Sizes available

- | 9kg tub
- | Coverage 21m²*

COMPARISON CHART

	COMPOUND	GROUT	
USE	Use on Porcelain & Ceramic	✓	
	Use on Stone & Concrete	✓	
	Driveway applications		✓
	Pedestrian applications	✓	✓
	Internal use		✓
	External use	✓	✓
FINISH	Smooth finish		✓
	Granular finish	✓	

INSTALL

Adjustable Risers

Pavetuf Adjustable Risers are designed to enable the simple installation of paving or decking for patios, flat roofs, terraces and balconies.

The system allows the:

Levelling of patios, flush to buildings, without compromising damp proof courses, to create sleek inside to outside areas.

Conversion of unused rooftops and decks into attractive, hard wearing areas, increasing the footprint of properties.



Scan for full product information and for technical guidance



Easy to install



No tread noises



Fast drainage



Big load capacity



Handy levelling



Made from recycled materials and are recyclable



1 Choose your base

First of all select the correct base that goes up to your required height.



2 Select the right top plate

All Top Plates fit into any base or side base. Choose the one to suit your application.



3 Add accessories to assist in easy installation



- ▶ Side bases for easy edge installation.
- ▶ Self Levelling for up to 5% correction of uneven surfaces.
- ▶ Slope Corrector for small slope adjustments from 2% to 10%.
- ▶ Edge Finishing Plates to help create a fascia.
- ▶ Extension to raise the height where needed.
- ▶ Rubber accessories to aid noise reduction.

Edging

STAINLESS STEEL EDGINGS AND INLAYS

Our edgings create a decorative profile for the edge of 18-20mm porcelain and stone paving. Designed for use externally, with matching internal and external corner pieces, they are ideal for creating a clean and contemporary finish on raised patio areas, steps, swimming pools and borders.

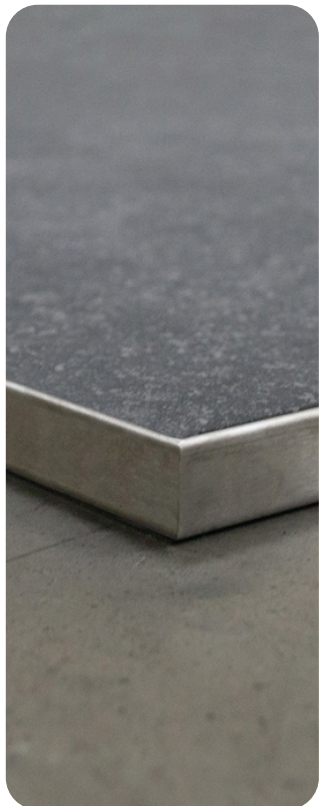

Accessories

PAVETUF SQUEEGEE



Pavetuf Squeegee is the ideal tool for the quick and simple application of Jointing Compounds & Mortars into paved areas.



PAVETUF PORCELAIN BLADE

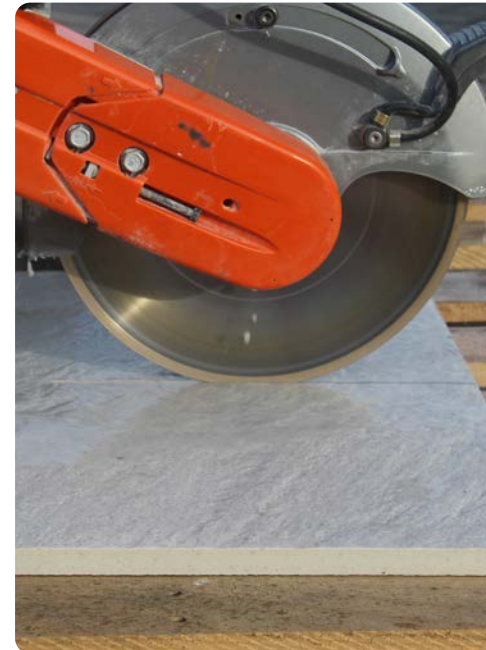

A specialist wet cut blade designed to cut porcelain.

Blade specification:

- ▶ 300mm (diameter) x 2.8mm
- ▶ 20 diameter bore
- ▶ OSA approved
- ▶ EN 13236
- ▶ Recommended RPM 3100 up to a maximum of 5100

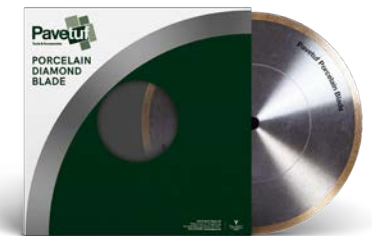

INSTALL

Drainage

Pavetuf Decorative Channel Drain offers a lightweight, durable and easy to install drainage system. Whether you need garden or patio drainage, our system offers a choice of colours, patterns and finishes, to enhance your paved area and landscape.

BENEFITS

- ✓ Quick fix durable design
- ✓ Component parts snap together
- ✓ Channel can be cut to length
- ✓ Made from polyolefin, which is lightweight and easy to install
- ✓ Recyclable
- ✓ UV inhibitors prevent fading and cracking in the sun
- ✓ Chemical resistant
- ✓ Ideal for light duty applications
- ✓ Grates are removable for quick inspection and maintenance

Load class A15/B125 in accordance with EN1433:2003

Maximum load 4.0t / 8,818lbs (A15 for channel only)

Maximum load 9.5t / 29944lbs (B125 in combination with grate, surround by ready mix)

GRATES

Slotted Grate
Grey and buff



Fallen ash leaf grate
Grey, black and cast iron*



Checker board swirl grate
Grey



*Will rust to a corten effect

CATCH BASINS



Buff

Slotted
Grey and buff



Cast Iron

Fallen ash leaf
Grey, black and cast iron*



Grey

Checker board swirl
Grey



Checker Board Swirl Grey →



Fallen Ash Leaf Black →

DECORATIVE CHANNEL DRAIN COMPONENTS (B125)

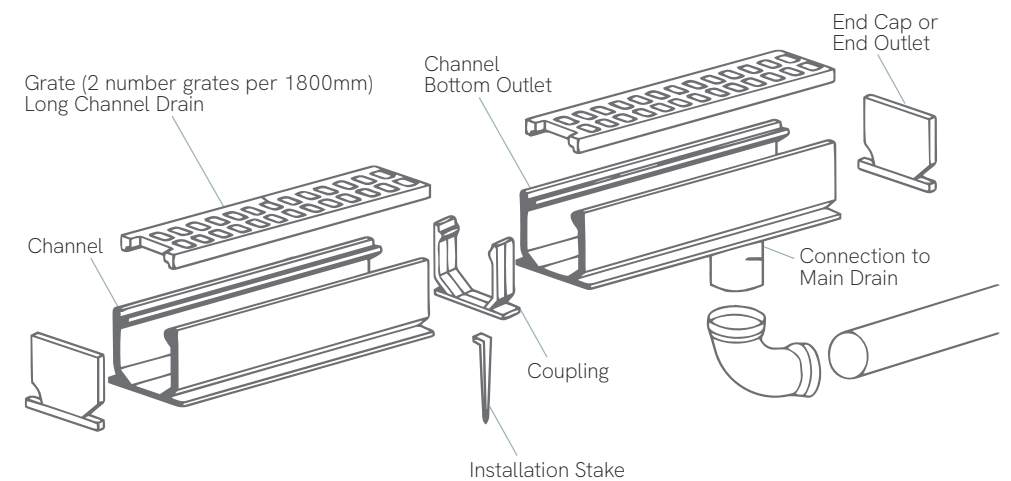



How to use guides

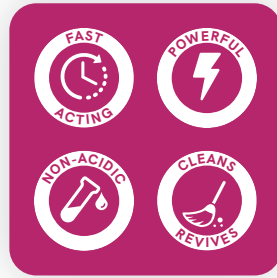

Cleaners

To keep your products looking spick and span all year round, you can rely on our comprehensive range of Pavetuf specialist cleaners.

The range boasts twelve different options and has been designed for general everyday use, through to removing specific stubborn stains.

Using the wrong cleaners can damage your investment!

Sealer & Resin Residue Remover

COMPARISON CHART

	Deep Cleaner*	Resin Bound Cleaner	Green Off Cleaner	Wood Deck Cleaner	UPVC & Fascia Cleaner	Wall & Render Cleaner	Composite Cleaner	General Cleaner*	Rust Remover	Salt Eraser	Porcelain Cleaner*	Sealer & Resin Residue Remover
Algae, moss, mildew, fungi			✓	✓	✓	✓						
Black & White spot lichens			✓									
Heavy soiling	✓	✓	✓	✓	✓	✓	✓					
Light soiling	✓	✓	✓	✓	✓	✓	✓	✓			✓	
Grease & Oil*	✓	✓										
Leaf & plant staining	✓		✓	✓	✓	✓						
Bird droppings	✓	✓	✓	✓	✓	✓	✓	✓			✓	
Efflorescence/salts									✓			
Rust/iron ore								✓				
Solvent sealers, paints/varnish												✓
Mud	✓	✓	✓	✓	✓	✓	✓	✓			✓	
Atmospheric pollution	✓	✓	✓	✓	✓	✓	✓	✓			✓	
BBQ grease, oily food stains*	✓	✓										
Resin based residue												✓
SIZE												
1 litre								✓		✓		
5 litre	✓	✓	✓	✓	✓	✓	✓	✓	✓	✓	✓	✓



DEEP CLEANER



RESIN BOUND CLEANER



GREEN OFF CLEANER



WOOD DECK CLEANER



UPVC & FASCIA CLEANER



WALL & RENDER CLEANER



COMPOSITE CLEANER



GENERAL CLEANER



RUST REMOVER



SALT ERASER



PORCELAIN CLEANER



SEALER & RESIN RESIDUE REMOVER



How to use guides

Sealers

Our range of Pavetuf sealants have been designed to delay the penetration of water and oily liquids, allowing time to clean up any spillage to prevent staining of the hard landscaped area. With the added benefit of being breathable, not only can they be used to seal your paving before installation, they can also be used immediately after.

All sealants can be used both internally and externally. We recommend using a paintbrush for internal products.



COMPARISON CHART		INVISIBLE	SATIN	BACK TO BLACK
FEATURES	Environmentally Friendly	✓	✓	✓
	Colour Enhancing			✓
	Waterproofing	✓	✓	✓
	Breathable	✓	✓	✓
	Stain Resistance	✓	✓	✓
	UV stable	✓	✓	
USE ON THESE MATERIALS	Use straight after installation	✓	✓	✓
	Black slates, granites & limestones	✓	✓	✓
	Slate & limestone	✓	✓	
	All other natural porous products and stone	✓	✓	
	Masonry	✓	✓	
	Brick work	✓	✓	
LOOK	Concrete Paving	✓	✓	
	Tarmac			✓
	Invisible Finish	✓		
	Satin Finish		✓	

Invisible Sealer

The Invisible Sealer dries with a virtually invisible finish, ideal for those who want to protect their investment without altering the appearance.

5ltr Tub
Coverage: Approx 25-50m²



Satin Sealer

The Satin Sealer dries with a satin, slightly enriched look. This sealer is suited to those who want to slightly enhance the look and colour of the paved area, whilst also adding additional protection.

5ltr Tub
Coverage: Approx 50-75m²



Back to Black

Pavetuf Back to Black is a high-performance colour reviver and sealer which restores and enhances the appearance of faded black and dark coloured natural stone. Back to Black is especially suited for use on oxidised black and dark limestones, black slate, black granite and concrete paving.

5ltr Tub
Coverage: Approx 25-80m²

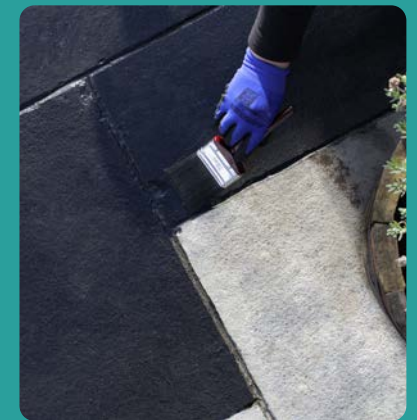

Terms & Conditions

General product information and guidance



ABOUT US

Talasey Ltd is one of the UK's leading suppliers of high-quality, ethically sourced landscaping products. We supply a large range of branded landscaping products including Natural Paving, Vitripiazza, Pavetuf, Luxigraze and Piranha to businesses and their consumers. We have a team of highly experienced sales and technical staff who are available to provide advice and guidance on our products. For further information please contact our Customer Experience Team on 0330 333 8030.

For further important details about our products please refer to our product brand websites (naturalpaving.co.uk, vitripiazza.co.uk, pavetuf.co.uk, luxigraze.co.uk and piranhadecking.co.uk).

UNDERSTANDING OUR PRODUCTS

We have Understanding and Installing Guides for all our ranges that we recommend you read prior to purchase. They are designed to help you with your choice, what to expect upon delivery, some basic installation advice and how to look after your investment.

PURCHASING OUR PRODUCTS

If you would like to purchase any product/s from our range, please contact us directly through our Customer Experience Team. We can assist you by providing contact details for our network of stockists, designers and/or installers. All sales will be subject to applicable Terms and Conditions which are available directly upon request.

SAMPLES

Samples are available by enquiry through our Customer Experience Team, our website or through your local merchant.

DISTRIBUTION

Talasey Ltd's products are available to our stockists for collection or delivery from our distribution centres at Tilbury, Doncaster and Grangemouth.

UPON DELIVERY

All products must be checked on arrival and in the unlikely event of products reaching you in a less than satisfactory condition, please refer to your stockist immediately, allowing time for the affected product to be replaced. Do not install any affected product as we will be unable to consider changing it nor will we accept any installation costs. We recommend if you are going to be away from home whilst the product is laid by a contractor, check you're happy with it before you go.

DIMENSIONS

All sizes and coverages stated throughout this portfolio are estimates and will be subject to minor variation, subject to tolerances. Tolerances will vary from product to product and specific guidance should be sought from our Customer Experience Team before placing an order.

WASTAGE

Allow for cuts and positioning during install, allow for individual units with characteristics that may not be to the users personal liking and, in addition, consider that due to the nature of some of our products and the journeys that they endure to get to your door some breakages may be incurred. Therefore, we recommend that you order an additional 5-10% on the volume calculated.

SPECIFICATIONS

We reserve the right to change, or discontinue, any of our product specifications or designs without notice. We cannot accept any liability for products used for purposes that they were not intended for. We recommend taking expert advice on the suitability of products for your specific needs. The product names of our Natural Paving range do not always relate to the geology of the stone. Product Specification and Design Guidance documents are available on request, via your local merchant or stockist.

INSTALLATION

We have Planning and Laying Guides and/or technical advice available on our product brand websites, (as above), to assist your installation. If in doubt, always speak to a local expert and/or carry out research from reputable independent sources.

COLOURS

The images in this portfolio are only indicative of the shades, and their proportions, that may be represented in any given production batch, particularly with natural stone ranges. The colours shown are as accurate as reprographic processes allow.

Crates and packs should be mixed during installation to create a blend across your entire delivery to avoid colour banding, particularly relevant for Natural Paving, Vitripiazza and Pavetuf jointing products.

Mixing packs is recommended even if the entire delivery has been batch matched. Always try and order enough product to complete the project to minimise batch variation and try not to mix sources of supply without checking compatibility, prior to install.

Bear in mind, with natural products and those containing aggregates, as we or our partners, work through a quarry, shades will alter so batches bought previously, or installations shown in our imagery, may vary from current supply.

For Vitripiazza, it is strongly recommended you check all the product supplied is from the same production batch before commencing installation.

WEATHERING

Over time, environmental conditions and types of use will impact on our paving and walling products; from organic discolourations, such as algae, bird droppings and fallen leaves through to general soiling and tyre marks etc, and the appearance of our products may be affected. Darker staining agents will be more apparent on lighter coloured paved areas. Regular cleaning of all of our products is recommended.

Due to the composition of natural stone, and natural aggregates, and as its mineral content oxidises, colour variations may also occur.

Talasey cannot accept responsibility for any potential weathering characteristics or the effects of potentially deleterious materials.

MAINTENANCE & CLEANING

For full advice, refer to our Understanding and Installing Guides in our Knowledge Hub.

We have a wide range of Pavetuf maintenance and cleaning products to either help protect your products or make cleaning easier. Refer to our website www.pavetuf.co.uk.

HEALTH & SAFETY

For full advice, refer to our Understanding and Installing Guides in our Knowledge Hub and always follow the product labels. Material Safety Data Sheets are available on request.

It is your responsibility to ensure that you comply with all applicable health and safety legislation and guidelines.

DESIGNER & INSTALLER NETWORK

Please note that our scheme is designed to provide a list of members that are independent contractors, installers and designers, to assist you in choosing a landscaping professional. Talasey Ltd cannot accept credit or responsibility for their actions and work.

LEGAL NOTICE

The information in this portfolio, on the Talasey Ltd's website, in a guide or any document referred to herein (the "Materials") is for guidance purposes and intended to assist you in your purchase and enjoyment of the product. Talasey Ltd will have no responsibility or liability, howsoever arising, for reliance on the information provided in the Materials. Talasey Ltd's sole liability in respect of any products shall be as outlined in the terms and conditions of purchase or in any express guarantee relating to the product purchased. Any product guarantee referenced in the Materials is subject to terms and conditions. Whilst we work closely with our partners, any arrangement you make or advice you take from them will be subject to your contract with them. Talasey Ltd has no liability in respect of any act or omission of any third party. Every effort has been taken to ensure that the information contained in the Materials is accurate, specifications and tolerances will be as contained in your order for the products, and may differ from those stated in the Materials, particularly with respect to natural materials, where colours may differ from those illustrated.

Guidance provided by Talasey Ltd is generic and advice should be sought in respect of local environmental and building regulations as applicable.

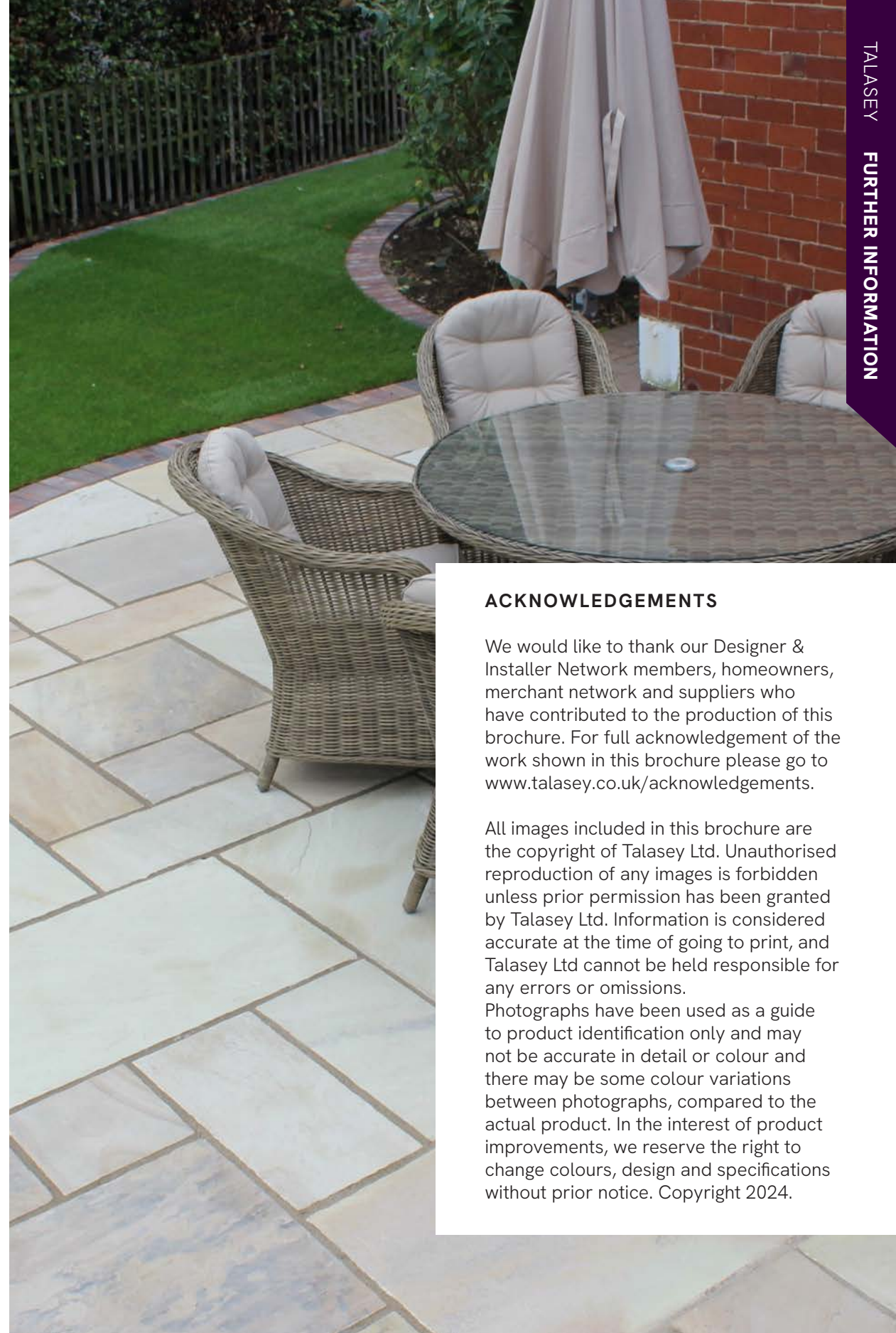

ACKNOWLEDGEMENTS

We would like to thank our Designer & Installer Network members, homeowners, merchant network and suppliers who have contributed to the production of this brochure. For full acknowledgement of the work shown in this brochure please go to www.talasey.co.uk/acknowledgements.

All images included in this brochure are the copyright of Talasey Ltd. Unauthorised reproduction of any images is forbidden unless prior permission has been granted by Talasey Ltd. Information is considered accurate at the time of going to print, and Talasey Ltd cannot be held responsible for any errors or omissions.

Photographs have been used as a guide to product identification only and may not be accurate in detail or colour and there may be some colour variations between photographs, compared to the actual product. In the interest of product improvements, we reserve the right to change colours, design and specifications without prior notice. Copyright 2024.



TALASEY

LANDSCAPING SOLUTIONS

Your local stockist



AVS

Web: www.avsfencing.co.uk

Tel: 01727 226 666

Email: sales@avsfencing.co.uk

AVS Fencing, Timber & Landscaping is the South and East's premium supplier of fencing and landscaping materials to the trade and DIY customers. Shop online or visit one of our branches where our experienced and friendly staff will be pleased to help you with any project. Same day/next day delivery available.

See our website to find your local branch.

Talasey Ltd
St Vincent House,
Normanby Rd, Scunthorpe
DN15 8QT

Tel 0330 333 8030

Email info@talasey.co.uk

www.talasey.co.uk

Follow us on social media for inspiration
and for the latest product announcements.

#InspiredByTalasey

